

INSTRUCTIONS FOR USE

WM75.2

Washing machine
W6098X/1/2/3

Dear Customer,

We thank you for purchasing this quality ASKO product.





We hope it meets all your expectations. Scandinavian design combines pure lines, everyday functionality, and high quality. These are the key characteristics of all our products, and the reason why they are highly appreciated across the globe.

We kindly recommend you to read these instructions before using the appliance for the first time. The instruction manual also includes information on how you can help protect the environment.

TABLE OF CONTENTS

Safety precautions	3	Cleaning and maintenance	41
Washing machine description	6	Errors – what to do?	46
Detergent compartment	6	Service	51
Before using the appliance for the first time	7	Technical information	52
Installation and connection	10	Program table	55
Tips before washing	17	Table: washing mode/temperature	58
Washing process, step by step (1 – 8)	19	Table options	59
Settings	31	Disposal	60
Special features	35	Quick guide	63

The following symbols are used throughout the manual and they have the following meanings:

	Information, advice, tip, or recommendation		Warning – danger of hot surface
	Warning – general danger		Warning – danger of fire
	Warning – danger of electric shock		

Original instructions

See Quick guide on the last page.



GENERAL



Please read the instruction manual and save it for future reference.

- **Please do not use the washing machine if you have not read and understood these instructions or use first.**
- Failure to observe the instructions for use or inappropriate use of the washing machine may result in damage to the laundry or machine, or injury to the user. Keep the instruction manual handy, near the washing machine.
- Instructions for use are available on our website at www.asko.com.
- **Your washing machine is intended solely for household use.**
- The appliance has to be connected to the water and power supply by a trained expert.
- Any repair and maintenance pertaining to safety or performance should be done by trained experts.
- To avoid hazard, damaged power cord may only be replaced by the manufacturer, authorized service technician, or other authorized person.
- After installation, the washing machine should stand still for two hours before it is connected to the power mains.
- The washing machine may not be connected to the power mains using an extension cord.
- Do not connect the washing machine to an electrical outlet intended for an electric shaver or hair dryer.
- To connect the washing machine to water supply, make sure to use the supplied water supply hose and gaskets. Water pressure has to be between 0.1 and 1 MPa (approximately 1–10 kp/cm², 1-10 bar, 10–100 N/cm²).
- Always use a new water supply hose to connect the appliance to water supply; do not reuse an old water supply hose.
- **After the washing cycle, close the water tap and pull out the washing machine plug from the power socket.**
- Only use the washing machine for washing laundry, as described in the instruction manual. The machine is not intended for dry cleaning.
- In case of incorrect appliance connection, incorrect use, or servicing by an unauthorized person, the user shall bear the cost of any damage.
- Only use detergents intended for the washing machine!
- Only use agents for machine washing and care of laundry. We shall not be responsible for any damages or discolouration of gaskets and plastic parts resulting from incorrect use of bleaching or colouring agents.

- Bleaches that contain chlorine can be replaced with oxygen-based bleaches. Otherwise, a neutralization cycle should be performed by running the Cotton program at the highest temperature. For best results, use hydrogen peroxide or oxygen-based detergents.
- Do not use colourants (dyes) or bleaching substances (substances for discolouration or removal of colourants) as they contain sulphuric compounds that could cause corrosion.
- Excessive use of products containing chlorine compounds increases the risk of premature failure of appliance components. This depends on the concentration of chlorine, exposure time, and temperature.
- ⚠ Do not use detergents that contain solvents as this could lead to release of poisonous gases, damage to the machine, and risk of fire and explosion.
- Before using the appliance for the first time, remove the transport bolts and all other transport protection devices. See chapter "BEFORE FIRST USE / Transport protection".
- The machine is not intended for use by persons (including children) with physical or mental impairments, or persons with lacking experience and knowledge. These persons should be instructed about the use of the appliance by a person responsible for their safety.
- Emergency door opening tool is located on the back side of the dispenser.
- Maximum washing capacity in kg is indicated on the rating plate (or in the PROGRAM TABLE).

CHILD SAFETY

- Do not allow small children to play with the washing machine.
- Before closing the washing machine door and running the program, make sure there is nothing except laundry in the drum (e.g. if a child climbed into the washing machine drum and closed the door from the inside).
- Keep the detergent and conditioner out of reach of children.
- **Activate the child lock.** See chapter "SETTINGS, section Child Lock".
- **Do not let children younger than three years to come near the appliance, unless they are under constant supervision.**
- The washing machine is made in compliance with all relevant safety standards. This washing machine may be used by children aged 8 years and above and by persons with reduced physical, sensory or mental capabilities or lack of experience and knowledge, but only if they are supervised during the use of the appliance, if they have been provided relevant instructions regarding safe use of the washing machine, and if they understand the hazards of inappropriate use. Make sure children do not play with the

appliance. Make sure the children do not clean the washing machine or perform any maintenance tasks without supervision.

DANGER OF HOT SURFACE

- At higher washing temperatures, the door glass will heat up. Be careful to avoid burns. Make sure children do not play near the door glass.

WATER OVERFLOW PROTECTION

- If the water level in the appliance rises above the normal level, then the excessive water level protection will be activated. It will shut off the water supply and start pumping out the water. If the water level does not decrease in 60 seconds, the program will be interrupted (see chapter "ERRORS – WHAT TO DO?").

TRANSPORTING / STORAGE DURING THE WINTER

If you transport or store the appliance in vehicles or rooms that are not heated and where the temperature could drop to below freezing point, please do the following:

- Clean the drain pump filter. See chapter "CLEANING AND MAINTENANCE".
- Close the water supply to the washing machine, undo the water supply hose from the water supply tap, and wait until the water flows out of the tap and the hose.
- After the drain pump filter is emptied, there can still be a small amount of water in the machine. This, however, does not affect the quality and will not damage the appliance.
- If the washing machine is to be transported, transport protection has to be re-installed before transport (See chapter "BEFORE USING THE APPLIANCE FOR THE FIRST TIME").

SAVE THESE INSTRUCTIONS FOR FUTURE REFERENCE!



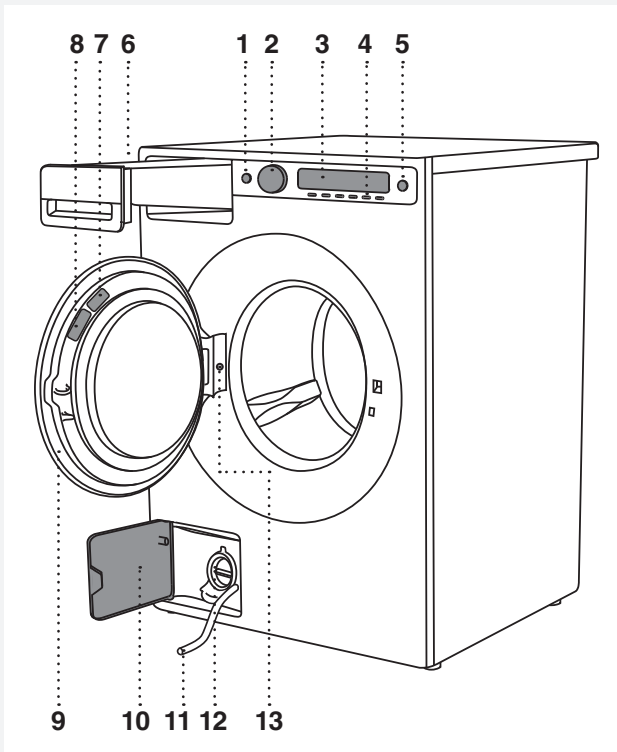



WASHING MACHINE DESCRIPTION

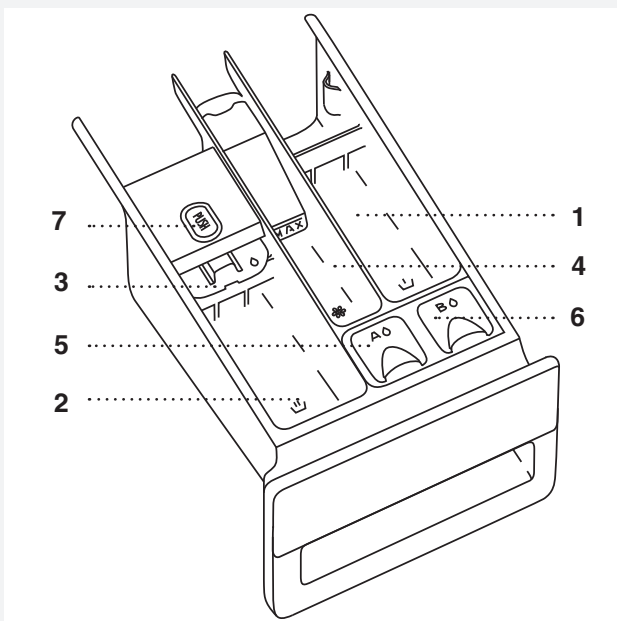

1. Main switch (ON/OFF)
2. Program selector knob
3. Display unit
4. Program settings buttons
5. Button (start/pause)
6. Detergent compartment
7. QR and AUID code (on the inside of the washing machine door)
8. Rating plate with information about the washing machine (on the inside of the washing machine door)
9. Washing machine door
10. Drain filter cover
11. Water release hose
12. Drain filter pump (installed behind the drain pump filter)
13. Drum illumination (depending on model)

DETERGENT COMPARTMENT



-  1. Prewash compartment
-  2. Compartment for main wash liquid detergent.
Use the foldable barrier (3).
-  2. Compartment for main wash powder detergent.
Do not use the foldable barrier (3).
-  4. Softener / conditioner compartment
-  5. Compartment (A) for liquid detergent for the Color program for the ADS.
(ADS = **A**uto **D**ose **S**ystem);
-  6. Compartment (B) for liquid detergent for the Black / White / Sensitive / Other program for ADS
-  7. Tab for detergent compartment removal

BEFORE USING THE APPLIANCE FOR THE FIRST TIME

PACKAGING

Remove all packaging.

Please sort the materials in compliance with local recommendations (see chapter "DISPOSAL").

TRANSPORT PROTECTION

Before using the appliance, remove the three transport bolts and plastic plugs which protect the appliance during transport.

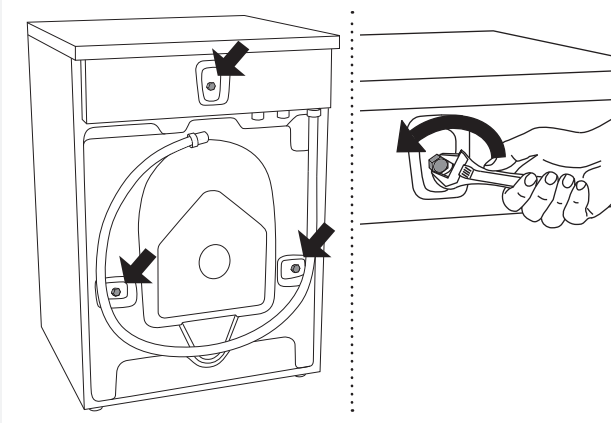

1 Release and remove the bolts as shown in the figures.

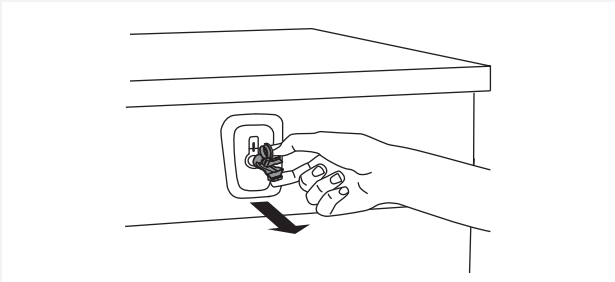

2 To remove the plastic plugs holding the bolts, squeeze them and then pull them out.

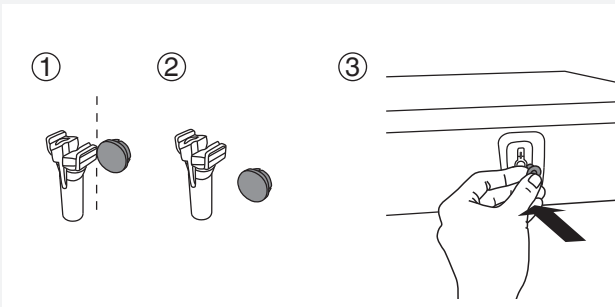

3 Remove the caps from the plastic plugs. Push the caps over the three holes in which the plastic plugs were inserted. Save the bolts and plastic plugs if you have to transport your washing machine in the future.

 If you wish to transport the washing machine, reinstall the bolts and plastic caps to lock the machine. This will prevent any damage to the machine due to vibrations during transport. If you have lost the transport bolts or plastic caps, replacements can be ordered at your dealer.

Art. No.	ID:
270698	Bolt
551188	Plastic cap (transport lock)

Please order three pieces of each item!

CLEANING

Disconnect the washing machine from the power mains and open the door. Clean the washing machine drum with a damp cloth and a mild detergent.

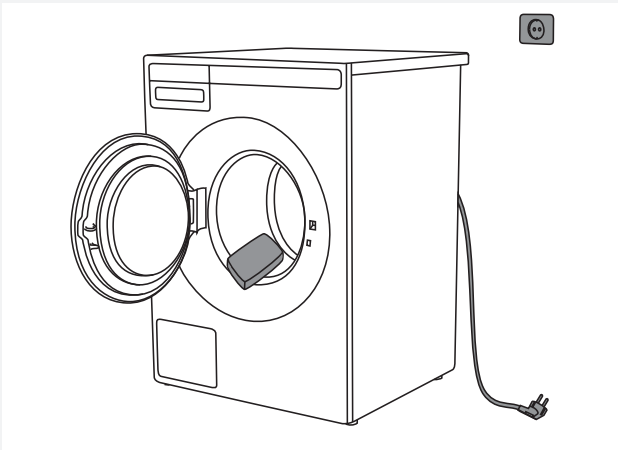

Connect the washing machine to the power mains and run the dedicated drum cleaning program. See chapter "WASHING PROCESS; STEP BY STEP (1–8)" /STEP 5: CHOOSE THE PROGRAM.

 No program can be started while the door is open.

SETTINGS BEFORE FIRST USE

After connecting the washing machine and power it for the first time, you will be asked to do following settings:

1. Language selection

Use the Program selector knob or buttons to scroll the list of languages.
Confirm the selection by pressing the "Set" button.

2. Water hardness

The following water hardness settings are available: soft / normal / hard.

How to use the test strip:

1. Turn on the water tap and let the water run for a minute or so.
2. Fill a glass with cold water.
3. Remove the test strip from its packaging.
4. Dip the test strip in the water for about one second.
5. Wait one minute. Now compare the colours of the squares with the water hardness table.

Test strip	°dH	°fH
4 green <input type="checkbox"/> <input type="checkbox"/> <input type="checkbox"/> <input type="checkbox"/>	< 3	< 5
1 red <input checked="" type="checkbox"/> <input type="checkbox"/> <input type="checkbox"/> <input type="checkbox"/>	> 4	> 7
2 red <input checked="" type="checkbox"/> <input checked="" type="checkbox"/> <input type="checkbox"/> <input type="checkbox"/>	> 7	> 12
3 red <input checked="" type="checkbox"/> <input checked="" type="checkbox"/> <input checked="" type="checkbox"/> <input type="checkbox"/>	> 14	> 25
4 red <input checked="" type="checkbox"/> <input checked="" type="checkbox"/> <input checked="" type="checkbox"/> <input checked="" type="checkbox"/>	> 21	> 37

Table for water hardness; See chapter "SETTINGS/WATER HARDNESS".

Confirm your selection with the button under the selected water hardness.

Press the "Next" button to confirm your selection.

For further washing process, see chapter "WASHING PROCESS; STEP BY STEP (1–8)".

💡 The amount of detergent also depends on the hardness of water. For details, see the detergent packaging. Please contact your local water supply company to check the water hardness in your area.

💡 In models with ADS the amount of detergent dispensed also depends on the water hardness setting.

💡 Before using the AD system for the first time, run one of the programs (without any laundry), after filling the A or B tank with liquid detergent (see chapter "SPECIAL FEATURES").

💡 Before the product is dispatched from the factory, every appliance is tested.

As a result, there may be some residual water left in the discharge pump filter. This, however, does not affect the quality and will not damage the appliance.

INSTALLATION AND CONNECTION

POSITIONING THE WASHING MACHINE

The washing machine can be installed as a built-in (integrated) or a free-standing unit. Place the machine on a level surface so that the power outlet on the wall is accessible.

💡 Before connecting the washing machine to the power mains, wait for at least 2 hours until it reaches room temperature.

💡 If the appliance is installed on a plinth or a similar structure, then the appliance must be fixed to it, to avoid the risk of falling. ASKO original accessories are available for this purpose, complete with fixing instructions.

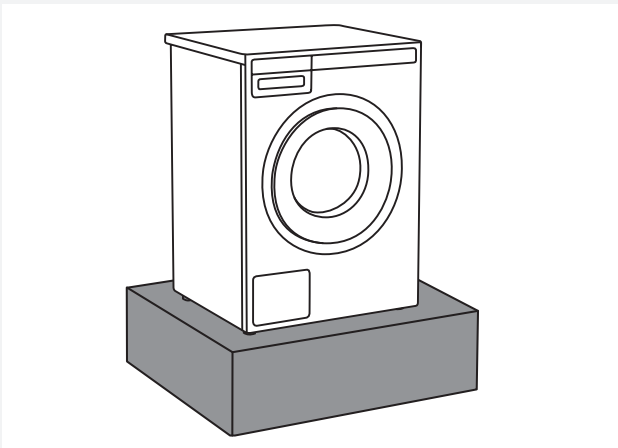

Built-in washing machine

The washing machine can be integrated under a worktop with a height of 900–950 mm. Leave 5 cm of room around the entire appliance, including between the back edge of the upper cover and the wall behind it.

Free-standing appliance

If you have a dryer of suitable dimensions (by another dryer manufacturer), use the vacuum feet to stack it on top of the washing machine, or place it next to it.

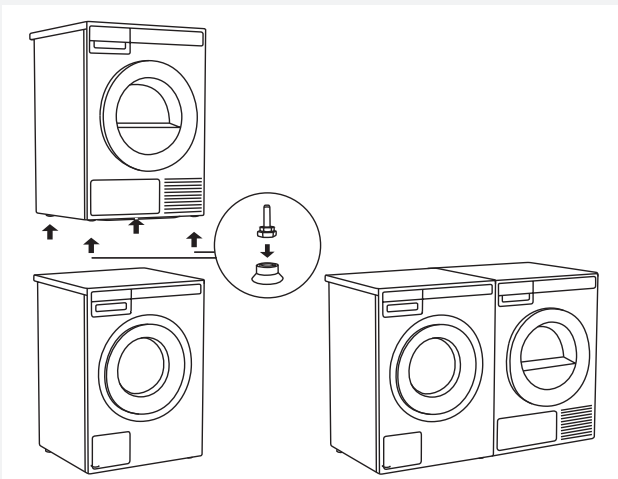

Clearances around the washing machine

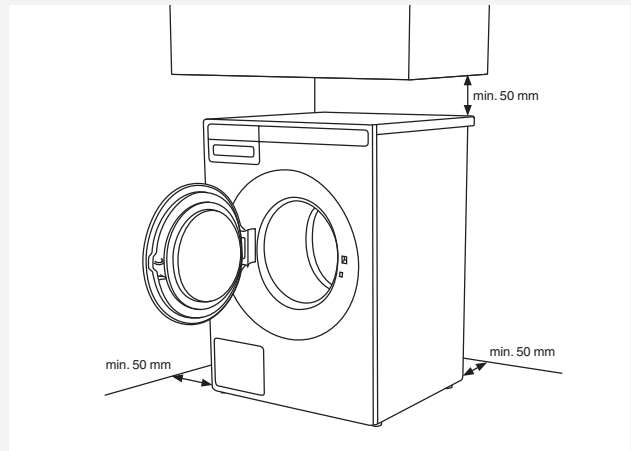

Opening the washing machine door (top view)

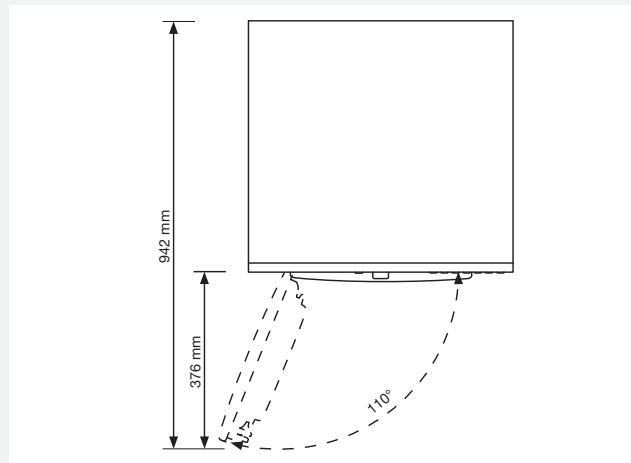

Stacking an ASKO dryer on top of an ASKO washing machine

To stack an ASKO dryer on top of a washing machine, use the extra vacuum feet and the tipping guard (A+B), supplied in the cardboard box in the ASKO dryer drum. If the washing machine and dryer are not of matching dimensions or if you have installed a hidden helper between the two appliances, then binding plates are available as optional accessories at the service unit.

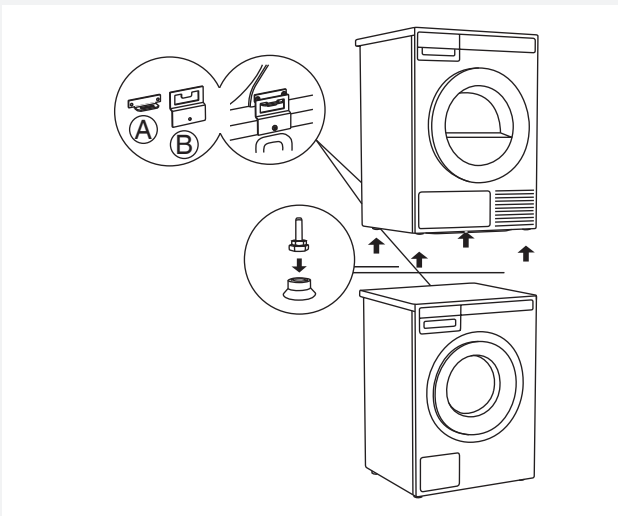

Ventilation Requirements of ASKO laundry concept or closet installation

ASKO's front panel controls make it possible to install the washers and dryers in a cabinet or closet.

Make sure there is clearance between appliances and cabinet or wall and 25 mm minimum clearance between the rear edge of the appliance top panel and the cabinet or wall.

When closet or cabinet is closed by the door, we recommend louvered doors, to ensure proper ventilation.

Otherwise there must be ventilation openings on the door. See illustration of dimension for ventilation openings below:

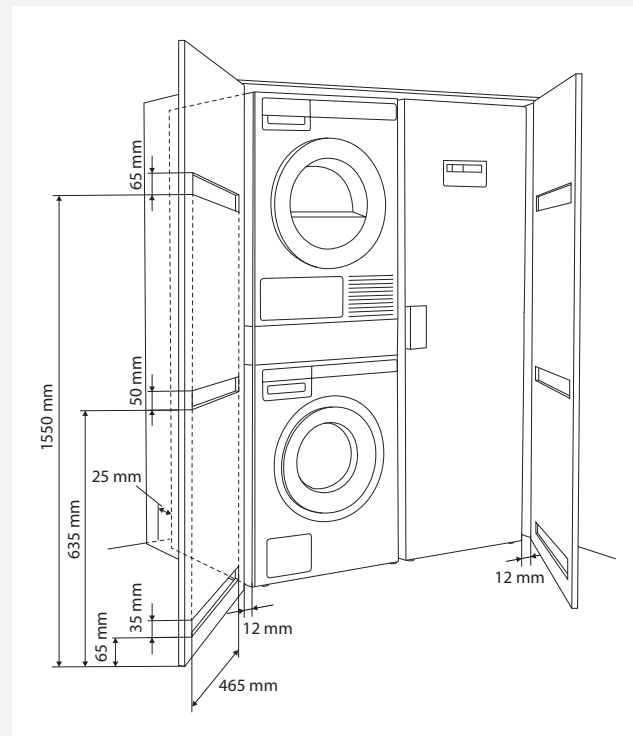

💡 Ensure the dryer door can be opened without hindrance after installation.

💡 The cool air intake panel at the front of the dryer must not be blocked or covered. Doing so could cause a fault.

⚠️ Disregarding of instructions influences on appliance performance and may also result in failure of the appliance.

ADJUSTING THE FEET

Place the washing machine so that it is stable.

1. Level the washing machine in longitudinal and traverse direction by rotating the adjustable feet (using a No. 32 spanner).
The feet allow levelling by +/- 1 cm.
2. When the appropriate height of feet is set, use the wrench No. 17 to firmly fasten the counter-nuts towards the bottom of the appliance .
3. Tighten the jam nuts (counter nuts) to the end position.
This will reduce washing machine noise, vibration, movement etc. to minimum.

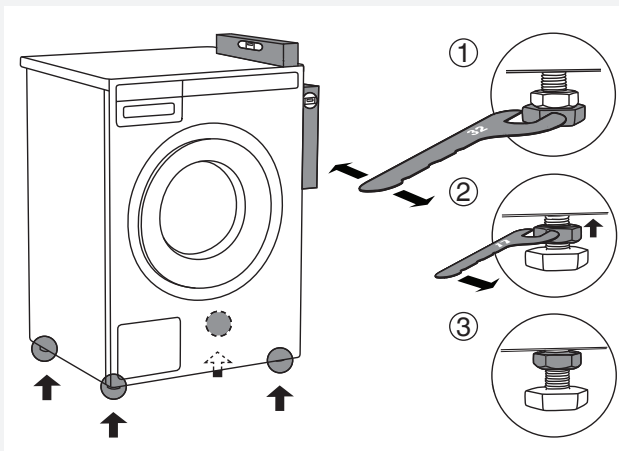

MOVING THE WASHING MACHINE AND TRANSPORT AFTER INSTALLATION

If you are moving the washing machine without packaging, open the washing machine door and pull the appliance by holding the washing assembly, as indicated in the figure.

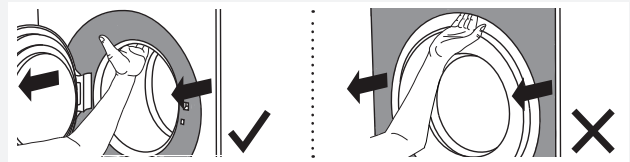

For any further moving of the appliance, use the transport rods (the washing machine drum has to be blocked).

(See chapter TRANSPORT PROTECTION.)

CONNECTING TO WATER SUPPLY

💡 The machine has to be connected to water supply by an adequately trained person.

Use the water supply hose to connect the appliance. Water pressure has to be between 0.1 and 1 MPa (approximately 1–10 kp/cm², 1-10 bar, 10–100 N/cm²).

If the hoses are newly installed, we recommend rinsing them to remove any impurities. Otherwise, these impurities could clog the filter in the water connection on the washing machine and thus cut off the water supply.

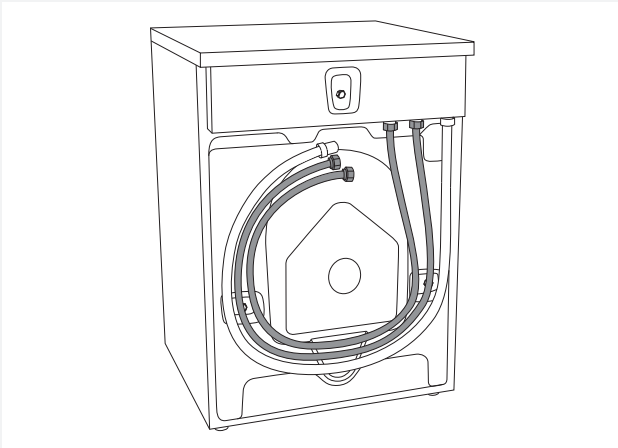

The water intake hose has to be fastened firmly enough for the hose to have a good seal. After connecting the hose, the seal must be checked for any leaks.

Only use the water supply hose supplied with the appliance. Do not use any used or other hoses.

💡 If the connection on the supply hose is of different dimensions than the water tap (e.g. 3/4" → 1/2"), use an adapter.

CONNECTING TO HOT/COLD WATER SUPPLY

(Only available in some models)

If your appliance has connections for both hot and cold water, then connect one hose to the cold water connection and the other hose to the hot water connection, as indicated on the back of the appliance:

COLD = cold and HOT = hot.

Hot water is supplied for programs operating at 40 °C or more.

💡 Connecting to both hot and cold water will save time and electric energy when washing.

If your washing machine model has connections for both hot and cold water, and you only wish to connect cold water, then the protective cap has to be (or remain) attached to the hot water connection.

INSTALLING THE DRAIN HOSE

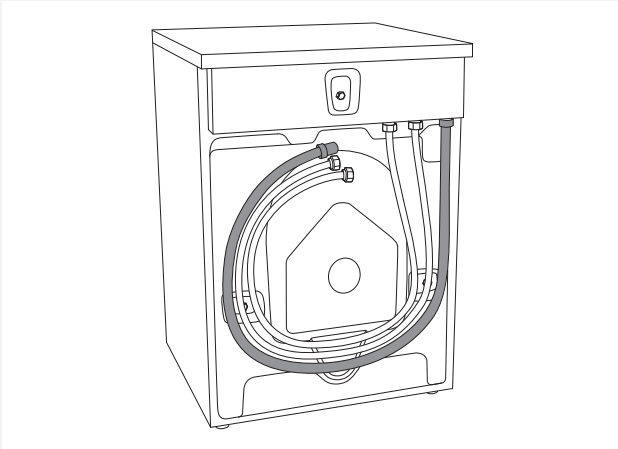

Upon delivery, the appliance has a drain hose attached. This drain hose must be connected to a drain. Drain hose can also be attached to a wall drain with a trap; such trap should be properly installed to allow cleaning. The height of the drain should be 600–900 mm above the floor. The lower position (600 mm) is always recommended. Make sure the drain hose is not clipped or bent.

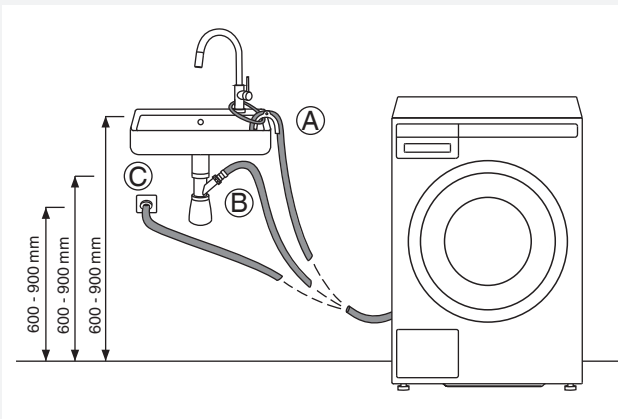

Drain hose can also be connected directly to the washbasin drain via a siphon. In this case, the hose, should be 600–900 mm above the floor. Internal hose diameter should be at least 18 mm. See figure.

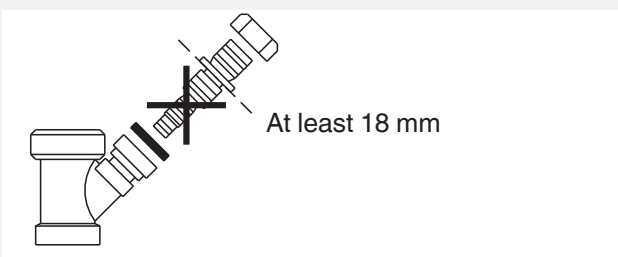

CONNECTING TO THE POWER MAINS

⚠ After installation, the washing machine should stand still for two hours before it is connected to the power mains.

Connect the appliance to an earthed power outlet. After installation, the wall outlet should be freely accessible. The outlet should be fitted with an earth contact (in compliance with the relevant regulations).

Connection upon delivery

TYPE: WMXX.XXXXX	MODEL: XXXXXX.X
Art.No.: XXXXXX/XX	Ser.No.: XXXXXXXX
XXX-XXX V ~ XXXX W ⇄ XXA	X kg CE
IPX4 XX Hz ⚡ XX-X MPa	

Information about your washing machine is indicated on the rating (type) plate.

Use the type A differential current protection switch.

⚠ We recommend using over-voltage protection to protect the appliance in case of a lightning strike.

⚠ The washing machine may not be connected to the power mains using an extension cord.

💡 Do not connect the washing machine to an electrical outlet intended for an electric shaver or hair dryer.

💡 Any repair and maintenance pertaining to safety or performance should be done by trained experts.

ASKO LAUNDRY CARE - HIDDEN HELPERS*

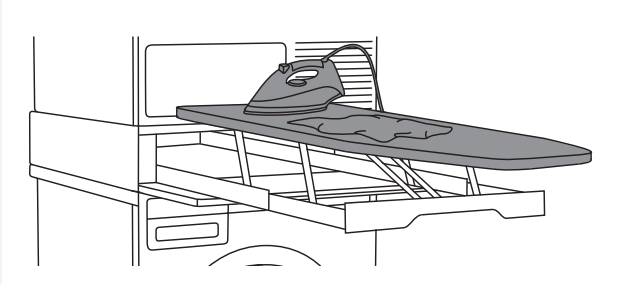

Laundry care ironing board

The ironing board is a clever solution. It is always handy when you need to iron your clothes, and it can be easily, safely and invisibly stored away when not in use.

It can be installed between your washer and dryer, or on top of one of them.

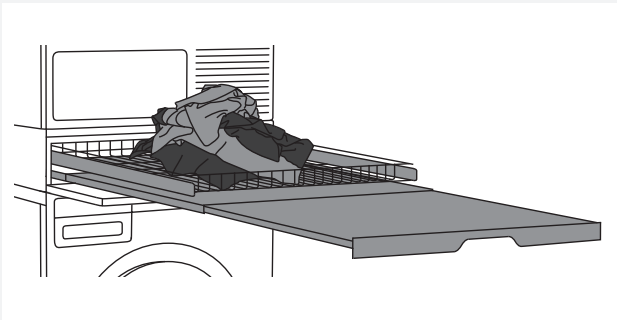

Laundry care double

A wire basket and pull-out shelf. It can be used as an additional surface for folding clothes, sorting socks and for storage. The basket is useful for removing and carrying laundry to the wardrobe or workbench for ironing and folding.

It can be installed between your washer and dryer, or on top of one of them.

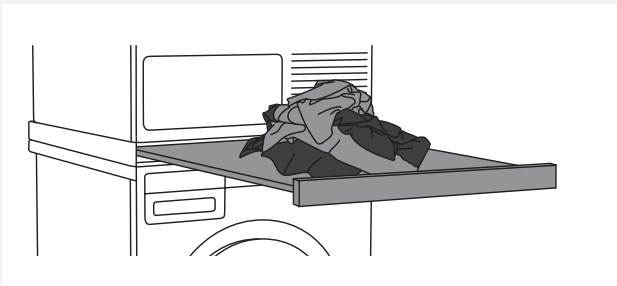

Laundry care single

Pull-out shelf. It can be used as an additional surface when folding clothes and sorting socks or for storage. It also makes loading and unloading your laundry much easier.

It can be installed between your washer and dryer.



Laundry care basket

A large pull-out basket that is easily accessible via a push-pull door opening. Useful for removing laundry and carrying it to the wardrobe or workbench for ironing and folding.

It can be installed between your washer and dryer, or on top of one of them.

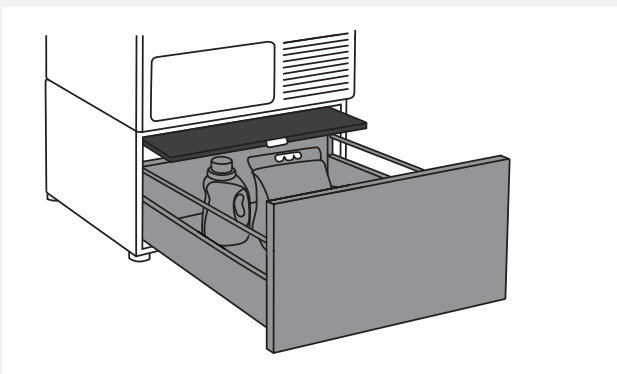

Pedestal drawer with shelf

A useful storage drawer with a height of 30 cm. Ideal for storing your detergent, softener, coat hangers, pegs, user manuals and other useful items in the laundry area. The drawer also comes with a shelf for easy loading and unloading of your laundry.

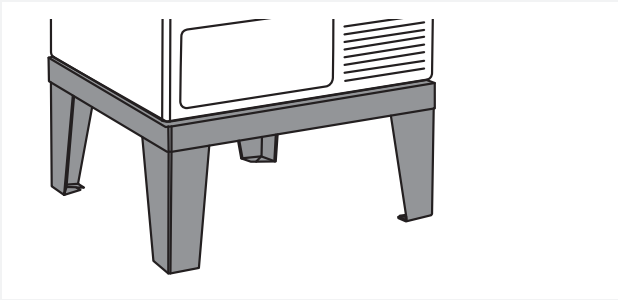

Laundry care plinth

Thanks to the stainless steel plinth, your appliance will be raised by 30 cm, which makes loading and unloading of laundry easier.

*AVAILABILITY DEPENDING ON MARKET

DENOMINATION	ART. No.
IRONING BOARD HI1153 White	576552
IRONING BOARD HI1153 Stainless steel	732756
IRONING BOARD HI1153 Titanium	576553
LAUNDRY CARE DOUBLE HDB1153 White	576554
LAUNDRY CARE DOUBLE HDB1153 Stainless steel	732757
LAUNDRY CARE DOUBLE HDB1153 Titanium	576555
LAUNDRY CARE SINGLE HSS1053 White	576730
LAUNDRY CARE SINGLE HSS1053 Titanium	576732
LAUNDRY CARE HB1153 White	576733
PEDESTAL DRAWER W. SHELF HPS5323 White (only 8 kg or 9 kg models)	576735
PEDESTAL DRAWER W. SHELF HPS5323 Stainless steel (only 8 kg or 9 kg models)	576737
STAINLESS STEEL PLINTH HPL530S for 8 kg and 9 kg models	441663
STAINLESS STEEL PLINTH HPL830S for 11 kg and 12 kg models	445501

TIPS BEFORE WASHING

This chapter includes several tips on how to prepare the laundry for washing.

LAUNDRY SORTING

Sort the laundry according to:

- how soiled it is,
- colour,
- material.

CLOTHING

1. Close the zips and hook-and-loop fasteners so that they do not damage the fabric.
2. New dyed items may contain excess dye; therefore, they have to be washed separately several times.
3. Turn delicate items inside out. This will decrease the risk of tear and colour fading.
4. Place very sensitive clothes and small items in a special-purpose laundry washing bag.
5. Empty the pockets and turn them inside out.

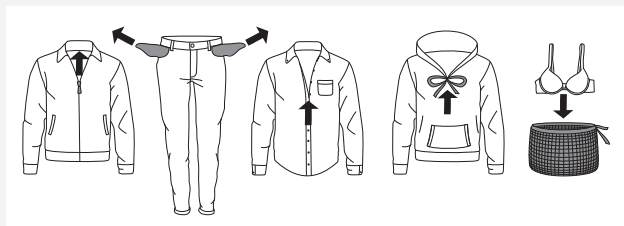

LAUNDRY SYMBOLS

Observe the laundry symbols.

Textile maintenance symbols:

Washing		
Normal		Delicate
	Max. washing temperature 90 °C	
	Max. washing temperature 60 °C	
	Max. washing temperature 40 °C	
	Max. washing temperature 30 °C	
	Hand wash only	
	Do not wash	
Bleaching		
	Bleaching in cool water	
	Bleaching not allowed	
Dry cleaning		
	Dry cleaning with all agents	
	Perchloroethylene R11, R113, petroleum	
	Dry cleaning in kerosene, pure alcohol, and R113	
	Dry cleaning not allowed	
Ironing		
	Ironing with a hot iron with a maximum temperature of 200 °C	
	Ironing with a hot iron with a maximum temperature of 150°C	
	Ironing with a warm iron with a maximum temperature of 110°C	
	Ironing not allowed	
Natural drying		
	Drying on a flat surface	
	Drying without prior spinning	
	Drying on a clothes line or a hanger	
Tumble drying		
	Drying at high temperatures	
	Drying at low temperatures	
	Tumble drying not allowed	

DYED COTTON

Laundry made of dyed cotton which is to be washed at 60 °C should be first washed at a temperature of 60 °C to remove the excess dye. If this is not done, there is danger of dye being washed out of such items. **To maintain the colour of the fabric, use bleach-free detergent.**

UNBLEACHED LINEN

Unbleached lining fabric should be washed at 60 °C with a detergent free of bleach or optical bleaching agents. Heavily soiled linen laundry may be occasionally washed at higher temperatures, but do not do this too often as heat could ruin the sheen and strength of linen clothing.

WOOL

These fabrics are intended for either machine or hand wash. The Wool/Hand Wash program is equally gentle or even gentler than an actual hand wash.

Wool in particular is sensitive to washing and similar procedures.

If you do not wish to spin your clothes, select a setting without spinning (see "STEP 6: Choose the program settings /button 3"). However, most garments are suitable for at least a **short spinning cycle**. Top spinning speed available is 800 rpm.

VISCOSE AND SYNTHETIC FIBRES

Materials made of viscose and some synthetic fibres are highly sensitive, and require a lot of space in order not to crease. When washing, **only fill the drum to a half** and choose a program with spinning speed of no more than 1200 rpm.

 Viscose and acetates are fragile when wet.

REDUCING ALLERGIC REACTIONS

(Only in some models)

The options include washing with the Allergy Program Cotton and Allergy Program Synthetics, using the Allergy Mode program setting, or using an extra rinse (Super Rinse). These programs, program settings, and functions **can be used for people with sensitive skin**, such as those suffering from allergies, or small children.

SAVING TIME AND ENERGY

To save time and energy, use the Universal wash. This program has **shorter main wash** cycle than Cotton and often suffices for less soiled laundry.

ECONOMY AND EFFICIENCY

You can save a lot of energy by not using the programs operating at higher temperatures. Choose the Quick program if you wish to only refresh the laundry; or use the Time program. **This will save water and power.**

Selecting the maximum spinning speed will **reduce power consumption** if you dry the clothes in a dryer or a drying cabinet.

When using the programs Heavy, Universal wash and Cotton, we recommend washing a full load. Avoid prewash. Modern washing machines and detergents are efficient without the prewash as well. **Prewash is only necessary for heavily soiled laundry.** Use the additional function Prewash (see "STEP 6: Program Settings Menu – choosing extra functions / button 5").

DETERGENTS

Detergents carrying the environment protection label are less harmful to the environment.

Only add the detergents in compliance with the recommendations by detergent manufacturers.

Recommended amount of washing detergent at certain loads and water hardness levels are specified on the detergent packaging.

STAINS

If your clothes are soiled with stubborn stains (blood, eggs, coffee, grass etc.), they should be appropriately treated before the wash. Then, wash your laundry using the special programs (if your washing machine has them).

Do not use any chemical substances or agents; only use the stain removing detergents.

DYEING FABRICS

If you wish to dye fabrics in the washing machine, choose the Universal wash program with the Super Rinse extra function. **Choose the temperature according to the dye manufacturer's recommendations.** If you dye mixed fabrics, such as polyester/cotton, choose a low spinning speed.

Add the dye directly into the drum, rather than in the detergent compartment. After dyeing use the Drum Cleaning program (self-cleaning program). Use the standard amount of detergent.

When using bleaches or stain removal agents, there is danger of corrosion and discolouration.

 To protect the environment, we advise against using powerful chemicals.

WASHING PROCESS, STEP BY STEP (1 – 8)

STEP 1: SORT THE LAUNDRY

See chapter "TIPS BEFORE WASHING"

💡 Use a washing net for underwire bras. Empty the pockets. Coins, nails etc. could damage the machine and the fabric.

STEP 2: TURN ON THE MAIN SWITCH.

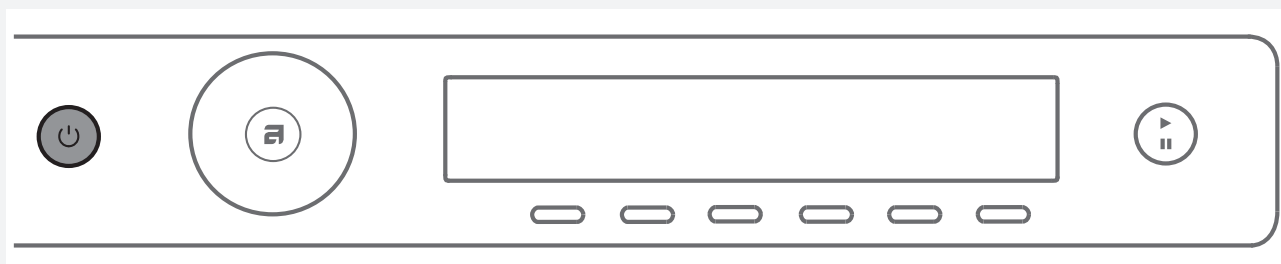

Turning on / Turning off

Press the  on/off button.

If the machine does not accept the on/off command correctly, wait for at least 8 seconds before pressing any other button.

STEP 3: OPEN THE WASHING MACHINE DOOR AND INSERT THE LAUNDRY.

Open the washing machine door by pulling the handle towards you.

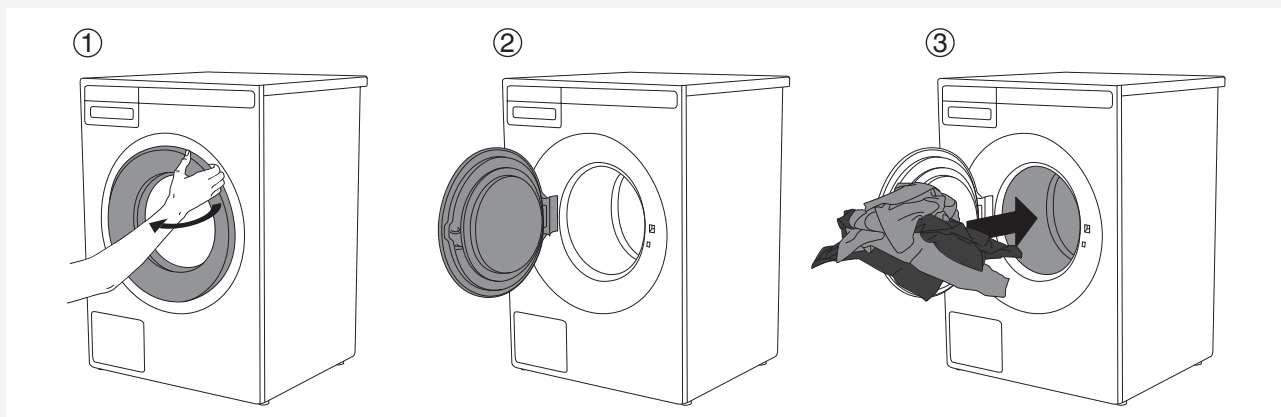

Place the laundry into the washing machine drum.
Before doing so, make sure the drum is empty.

Do not overload the drum!

If the washing machine drum is too full, the laundry will not be washed as thoroughly.

💡 With some models, the washing machine drum is also lit for 5 minutes when the washing machine is switched on.

💡 The lamp in the washing machine drum is not suitable for any other use.

💡 The lamp in the washing machine drum may only be replaced by the manufacturer, a service technician or an authorized person.

STEP 4: ADD THE DETERGENT AND THE CONDITIONER.

Recommended amount of detergent is usually specified on the detergent packaging. When washing a smaller amount of laundry, the amount of detergent used can be decreased.

Observe manufacturers' recommendations regarding the type of detergent suitable for certain temperatures, load size, and water hardness.

When using the ADS (**A**uto **D**ose **S**ystem), the appliance will automatically add the liquid detergent depending on the amount of laundry and the other selected settings.

Powder detergent

Add powder detergent into the main wash detergent compartment. If you have selected the Prewash function or Heavy program, Stain program: (Coffee or Fruit), or the Time program with 2:30 or longer duration, then add powder detergent to the prewash detergent compartment.

 We recommend adding the powder detergent immediately before the washing cycle. Otherwise, make sure the detergent compartment is completely dry before adding the powder detergent, as otherwise, the powder detergent may cake before the start of the washing process.

Liquid detergent

When using a liquid detergent, observe the detergent manufacturer's recommendations. When using thick detergents, we recommend always using the laundry balls. Use the barrier (3) in the detergent compartment; see figure in the chapter "DETERGENT COMPARTMENT". Add the liquid detergent in the front part of the detergent compartment (2).

Liquid detergent in ADS

The washing machine will automatically add the amount of liquid detergent according to the amount of your laundry and depending on how heavily soiled it is. Before adding the liquid detergent, pull out the dosing container as far as it will go.

Compartment (A) for liquid detergent for the Colour program.

Compartment (B) for liquid detergent for the Black / White / Sensitive / Other program.

See chapter "SPECIAL FEATURES".

In case of excessive foaming, check the water hardness settings (see chapter "SETTINGS"), how heavily soiled the laundry is, and the setting for the amount of liquid detergent according to the manufacturer's recommendations (see chapters "TIPS BEFORE WASHING").

ADS operation has been tested with liquid detergents by the leading global manufactures.

Use of other non-homogenized or homemade liquid detergents can cause malfunction of the ADS.

Any servicing required due to such problems shall not be covered by the warranty.

 The washing machine must be switched on before you add the detergent!

Laundry ball or washing bag

If you are using a laundry ball or a washing bag, place it directly into the drum and choose a program without any prewash.

 An excessive amount of detergent will not improve washing results. Rather, it will lead to foaming and increase the environmental impact. We recommend using less detergent. Only increase the dosage if you are not satisfied with the washing results.

Conditioner

Pour the conditioner into the detergent compartment, into the compartment with the symbol . Observe the recommendation on the conditioner packaging.

 Do not fill the conditioner compartment over the max. indication (maximum indicated level). Otherwise, the conditioner will be added to the washing machine drum too soon, leading to poorer washing effect.

STEP 5: CHOOSE THE PROGRAM.

Choose the program by rotating Program selector knob in either direction. Confirm the program selection by pressing the button under the program.

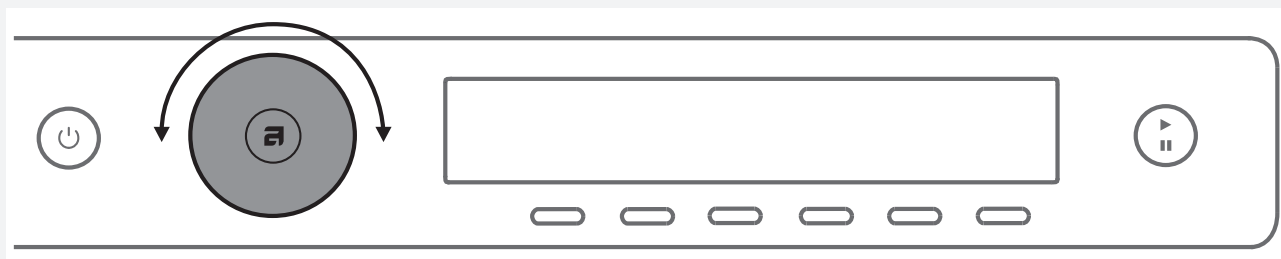

Choose the program depending on the type of laundry and how heavily soiled it is (see chapter "TIPS BEFORE WASHING").

Estimated program duration will appear on the display.

Extra program settings can also be selected for each program.
See STEP 6.

Choose between the following programs:

Program	Description
UNIVERSAL WASH	Program for lightly to moderately dirty laundry. The temperature can be set separately; therefore, observe the instructions indicated on the clothing. Wash the clothes worn directly on the skin at 60 °C. Less heavily soiled laundry will be thoroughly cleaned at 40 °C. Spinning speed can also be freely selected. Program duration and amount of water will be adjusted to the amount of laundry.
COTTON	Program for normally or heavily soiled laundry, white or coloured. The temperature can be set separately; therefore, observe the instructions indicated on the clothing worn directly on the skin. Choose 40 °C if the laundry is only lightly dirty. Spinning speed can be set to your preference. Default setting is maximum spinning speed. Program duration and amount of water will be adjusted to the amount of laundry.
ECO 40-60*	Washing cycle, which is able to clean normally soiled cotton laundry declared to be washable at 40 °C or 60 °C.
MIX/SYNTHETICS	Program for delicate clothing made of synthetic and mixed fibres or viscose, and for simple care of cotton. The highest available temperature is 60 °C. Observe the instructions indicated on the clothing. Most synthetic fabrics will be washed at 40 °C. Clothing worn directly on the skin should be washed at 60 °C. Maximum spinning speed is 1200 rpm; it can be decreased if necessary.
WOOL/HAND	Gentle program for washing wool, silk, and clothes that require manual washing. Maximum temperature is 40 °C. This program has a short spinning cycle. Top spinning speed available is 800 rpm.
DARK WASH	This program is used for washing dark laundry using special-purpose detergents for black laundry. We recommend turning dark garments inside out. The program washes at low temperatures, with gentle tumbling and 1200 rpm.

Program	Description
TIME PROGRAM	Use this program when you wish to wash the laundry for a specific amount of time. Duration can be set from 20 minutes to 3 hours (in 15-minute steps). In this program, select the corresponding washing time and temperature according to the type of laundry being washed.
AUTO	This program automatically adjusts the duration of the main wash and number of rinses depending on the amount of laundry in the machine.
QUICK	Quick program for lightly soiled laundry. The program operates at certain temperatures; therefore, observe the instructions indicated on the clothing. A lower temperature setting will result in shorter duration of the wash. Spinning speed can be set to your preference.
HEAVY	Program for heavily soiled laundry. The temperature can be set separately; therefore, observe the instructions indicated on the clothing. Maximum available temperature is 90 °C. It is suitable for very heavily soiled laundry. Spinning speed can be set to your preference. Program duration and amount of water will be adjusted to the amount of laundry.
EASY CARE	Program for delicate clothing made of synthetic and mixed fibres, and for simple care of cotton. It may also be used for pillows, quilted jackets and similar items, as it uses a lot of water for the wash. Carefully read the washing instructions. If the outer layer has a membrane, do not use a conditioner. Washing temperature can be set up to 60 °C, and spinning speed can be set up to 1200 rpm.
JEANS	Program for washing jeans. It uses low temperature and 1200 rpm. Due to a higher water level and an extra rinse, there will be no traces of detergent on the jeans.
SHIRTS	This program washes the collars and cuffs without wrinkling them. The wash takes place at a low temperature, with a greater amount of water and gentle tumbling. Steam is added at the end of this program in order to reduce occurrence of wrinkles. This feature is disabled in Speed Mode.
STEAM REFRESH	Use this program to refresh the laundry with steam (for laundry that does not yet need washing, only refreshing).
QUICK PRO	A quick program with high efficiency for smaller amounts of lightly soiled laundry. The program washes with intensive tumbling and 1200 rpm. (4 kg, 40 °C/ 50 °C/ 60 °C)
HYGIENE	This program is used to wash clothes that require special care, such as baby clothes, undewear or clothes for people suffering from skin allergies. We recommend turning the garments inside out as this will also thoroughly wash out the skin residues or residues of skin treatment products. The program is a combination of an extra long and high heating and extra rinsing with strong and sharp movements that removes any detergent residue.
SPORTS WEAR	This program is suitable for washing clothing with membranes, waterproof clothing, and breathable clothing, requiring simple care. It is suitable for sportswear made of mixed materials. It combines low temperature with gentle tumbling. Do not use conditioner with this program!

Program	Description
CONDITIONING	<p>This is short program suitable for washing waterproof clothes and clothing made of microfibres.</p> <p>This is short program suitable for washing waterproof clothes , if agent is used, and clothing made of microfibres.</p> <p>The program makes sure the clothes are waterproof and reduces adherence of dirt on the outer surface of the garments.</p> <p>Use of an impregnation agent is recommended.</p> <p>The program combines a short wash with cold water and gentle tumbling.</p>
STAIN PROGRAM	<p>Choose the fabric and stain type from the menu, and the right stain removal program will be automatically selected.</p> <p>You can choose between the following types of stains: red wine, blood, grass, blueberries, butter/grease, chocolate, coffee/tea, egg, dairy products, kids, baby.</p> <p>After selecting the type of stain, select the type of fabric (Cotton or Synthetics) and washing temperature for the selected type of fabric.</p> <p>See chapter "TIPS BEFORE WASHING".</p> <p>You can also choose the spinning rate.</p>
BEDDING	<p>This program is used to wash bedding, pillows, and larger items. Weekly wash of your bedding will remove skin residue and mites. Observe the instructions for washing and maintenance. The wash uses a large amount of water and extra rinse cycles.</p>
ALLERGY COTTON	<p>This program is used to wash normal to heavily soiled clothes that require special care, such as clothes for people with highly sensitive skin or skin allergies. We recommend turning the garments inside out as this will also thoroughly wash out the skin and other residues.</p> <p>You can also select the option to wash at maximum temperature and maximum spinning speed.</p> <p>Set temperature will be maintained for a longer time period than on conventional programs in combination with intense agitation and extra rinses.</p>
ALLERGY SYNTHETICS	<p>This program is used to wash clothes that require special care, such as clothes for people with highly sensitive skin or skin allergies. The program is also suitable for people sensitive to washing detergents. We recommend turning the garments inside out as this will also thoroughly wash out the skin and other residues.</p> <p>Set temperature will be maintained for a longer time period than on conventional programs in combination with intense agitation and extra rinses.</p>
RINSE	<p>This program includes 2 cold rinses and a short spinning cycle. The program is suitable for laundry that only needs rinsing, and for cleaning cloths or mops.</p>
SPIN	<p>Use the program when you only wish to spin the laundry.</p>
DRAIN	<p>If you only wish to pump out the water from the washing machine, choose the Drain program.</p>
DRUM CLEANING	<p>This program is used to clean the drum and to remove detergent residues and bacteria. The drum has to be empty. You can add some distilled (spirit) vinegar (approx. 2 dl) or sodium bicarbonate (1 tablespoon, or 15 g). We recommend that you run the programme at least once a month or when the text "Sterile Tube alert" appears in the display. Text "Sterile Tube alert" is displayed every 40 completed wash cycles.</p>

Program	Description
SETTINGS	<p>Use the program selector knob to choose Settings and confirm with button "6".</p> <p>Use the Program selector knob to scroll through the settings.</p> <p>The following options are available:</p> <ul style="list-style-type: none"> - Child Lock, - Language (language selection), - Temperature (temperature unit), - Auto Dose System (ADS), - Water (water hardness), - Sounds (acoustic signals), - Drum illumination, - Display (display unit: brightness & logo), - Programs (set of programs), - Reset. <p>See chapter "SETTINGS".</p>

* "eco 40-60" means the name of the programme declared by the manufacturer, importer or authorised representative as able to clean normally soiled cotton laundry declared to be washable at 40 °C or 60 °C, together in the same washing cycle, and to which the ecodesign requirements on energy efficiency, washing efficiency, rinsing effectiveness, programme duration and water consumption relate.

STEP 6: CHOOSING THE PROGRAM SETTINGS

Using the program settings, the washing programs can be further adjusted to your wishes.

Some program settings may not be available for your selected program.

Selected program settings will remain stored after the end of the washing cycle and may be changed subsequently (except for Start delay and Anti-crease, which are not stored after the wash is complete).

Programs with selected temperatures above 60 °C due to safety of your laundry will not be stored after the end of the washing cycle.

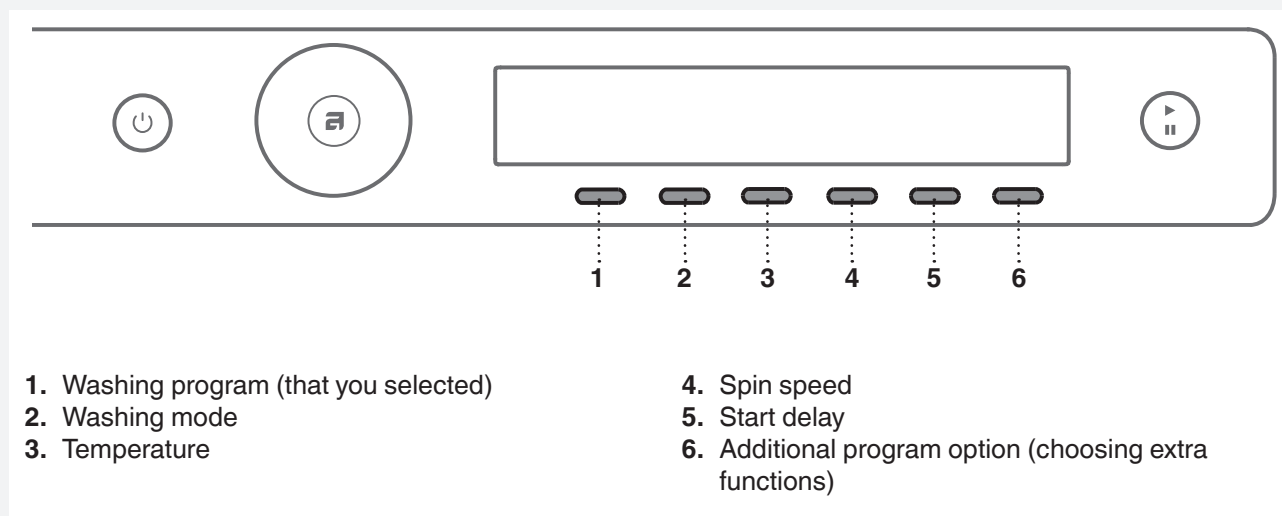

Choose the program settings before pressing the START button.







Program settings cannot be changed during the progress of a program.

 Press and hold the button under the program setting to display the information (INFO) about each program setting.

Following are the program settings that may be selected using the buttons 2 to 6:

2. Washing mode

The following washing modes are available:

-  *Normal mode / Off mode*
(Basic setting)
-  *Green mode*
(Wash that saves energy; longer washing time, lower water consumption).
-  *Speed Mode*
(Time-saving wash; shorter washing times, higher water and energy consumption).
In the Cotton program, we recommend a half-load.
-  *Allergy Mode*
(Wash with extra water, extra rinsing, extended washing time, higher water and energy consumption)
-  *Night Mode*
(Wash that reduces noise and extends washing time.)
-  *Intense Mode*
(Wash that improves cleaning performance, with extra water and extended washing time).

3. Temperature

The following temperatures are available for the selected program:

Cold wash and 20/30/40/50/60/70/80/90 °C.

The actual available temperature options will depend on the selected program.

4. Spin speed

The following spinning rates are available for the selected program: max. (rpm) /... / No drain (max rpm = depends on the model).

Default setting is 1400 rpm; it depends on the selected program (spin rate can be changed – reduced or increased (only in some models)).

The actual available spin speed will depend on the selected washing program.

 With the No drain option, the program will not include a spin cycle, and the water from the last rinse will remain in the washing machine. The laundry will stay in the water from the last rinse, which will prevent creasing. If you have selected the No d (No Drain) option, you have to select the Drain or Spinning program after the end of the washing program to pump the water out from the machine before you open the washing machine door.

5. Start delay

Choose the delayed start when you wish the washing program to start after a certain period of time (30' to 24 hours after you press the Start button).

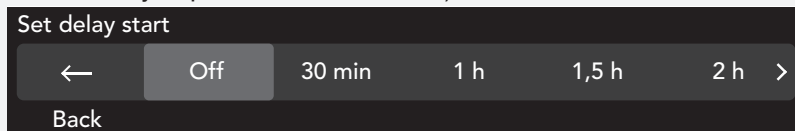

Use the Program selector knob to set the delay from 30' to 6 hours in 30-minute steps, and then from 6 hours to 24 hours in 1-hour steps.

Press the button to confirm your selection.

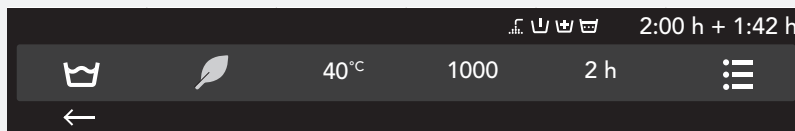

The estimated start delay time and time remaining until the end of the washing program will be indicated in the top line. When the countdown reaches zero, the selected washing program will start automatically.

To cancel or skip the delay and start the washing process immediately, press the 5 button (Skip).

When Start delay time is once set, it is not possible to change it; the only possibility is to »Skip it« (Skip delay) and continue with chosen program.

 If you have set the delayed start function and you are using liquid detergent, we do not recommend choosing a programme with a pre-wash cycle.

6. Selecting extra functions (Options/more options)

Press the button to confirm the extra settings. Then, use the Program selector knob to scroll the list of functions or options. Confirm your selection by pressing the button under the selected function or option. The following **extra functions** are available:

* **Favourite programs/Add to fav?**

To store the selected program as a favourite, press the  button and the program with all your settings will be stored.

The stored program will be displayed at the start of the Main menu.

Up to 6 favourite programs can be stored.

If you do not wish to store the program after the wash, rotate the Program selector knob and you will return to the program selection; or, simply open the washing machine door.

Changing a favourite program

If you wish to store a program after the end of the washing cycle, but there is no more room for another favourite program (only 6 favourite program slots are available), then one of the existing stored favourite programs can be substituted with a new one.

The list of favourite programs will appear when you switch on the washing machine.

* **Super Rinse (extra rinses)** (depending on model)



To increase the number of rinse cycles (+2), select the Super Rinse setting. This is recommended for persons with highly sensitive skin and/or in areas with very soft water. Confirm the selection by pressing the On / Off button.

Use the  button to return to Settings.

* **Prewash**

To use a prewash before the main wash, choose the Prewash option. Use of this function is recommended for heavily soiled laundry or for laundry with stubborn surface stains. Confirm the selection by pressing the On / Off button.

Use the  button to return to Settings.

Add the prewash detergent into the prewash compartment  and the main wash detergent into the main wash compartment  of the detergent compartment (see chapter "DETERGENT COMPARTMENT").

* **High water level**

For a larger amount of water after the wash and spinning cycle, select the High Water Level option. Confirm the selection by pressing the On / Off button.

Use the  button to return to Settings.

* **Anti-crease**

To prevent creasing the wash, choose the Anti-Crease option (gently tumbling). This function is recommended for delicate laundry. Confirm the selection by pressing the On / Off button.

Use the  button to return to Settings.

 Some functions may not be available on all programs.

STEP 7: START THE WASH

Close the washing machine door and press the **Start ▶/Pause** button.

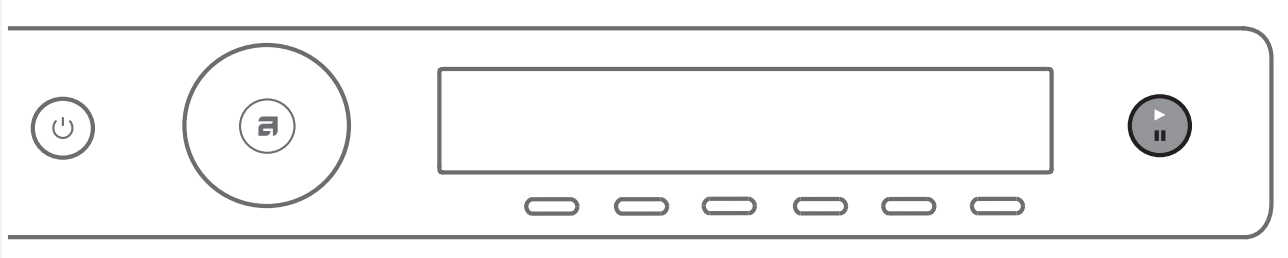

- ▶ Start (short press of the button – start/resume)
- || Pause (short press of the button – pause)
- Stop (press and hold for 3 seconds – stop or cancel)



Washing process (circle) is coloured:
 blue: beginning of the washing cycle
 red: not possible to add any more clothes
 green: end of the washing cycle

Remaining time

Depending on the selected program, anticipated washing time will be displayed in hours and minutes. Actual washing time will depend on the selected program, load, type of laundry, spin speed etc. Actual washing time may be longer or shorter than initially displayed. Remaining time will be updated during the program duration, depending on the actual amount of laundry and amount of water pumped into the machine. The last remaining time update takes place before the final spinning cycle. In case of uneven distribution of laundry, the time on the display will flash and it will not count down. Once the laundry is evenly redistributed, the washing time will continue and it will stop flashing.



Adding or removing laundry after the start of the program

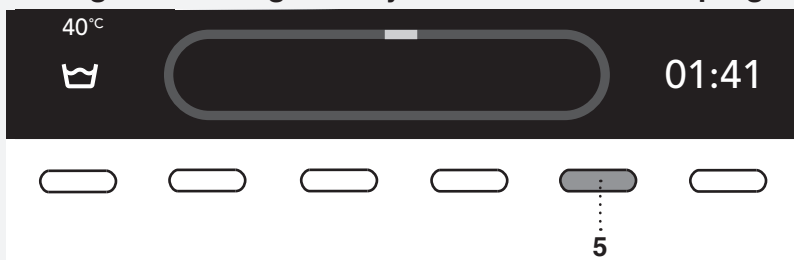

To add or remove laundry during the progress of a washing program, use the **Start/Pause ||** button to pause the program. Press the button 5 to choose Add Clothes, if the washing process (circle) is coloured blue. If the washing process (circle) is coloured red, this option is not available.

The door may be opened when the water is pumped from the machine (but not completely pumped out). Then, add or remove the laundry. Close the door and continue the program. Press the **Start ►/Pause** button. The program will resume from the point at which it was interrupted.

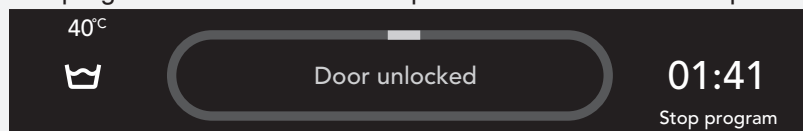

If the door cannot be opened, it is possible that the temperature in the machine is too high, and you won't be able to add the laundry.

Also, if the door cannot be opened, it is possible that the program has been running for too long and any laundry added at that point would not be efficiently washed.

Pausing, stopping or changing the program

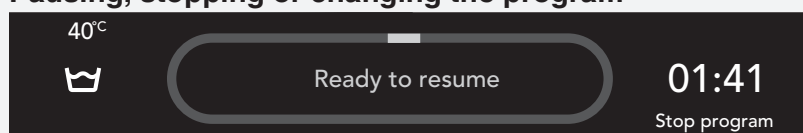

To pause the program, shortly press the **Start/Pause II** button.

To resume a program, press the **Start ►/Pause** button again.

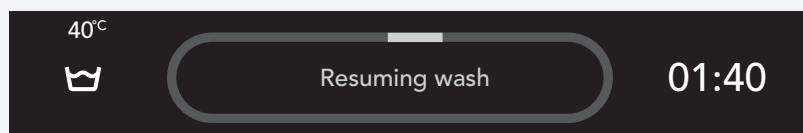

To stop the washing program, press the **Start/Pause** button and hold it for 3 seconds. Choose "Stop program". The program is canceled and the water is pumped out of the machine if necessary. Only then will you be able to open the washing machine door. Use the Program selector knob to select a new program. If necessary, add detergent, and then press the **Start ►/Pause** button.

💡 If the temperature in the drum is very high, then cooling procedure starts before program is canceled.

A washing program can be paused by pressing the ON/OFF button. The washing machine will switch off.

After the washing machine is switched on, press the **Start ►** button to resume the program.

💡 Do not open the detergent compartment while the appliance is operating.

💡 In some cases the door may be locked although no program is in progress (e.g. in case of an error). To unlock the door, press the **Start/Pause** button and hold it for a while.

STEP 8: END OF PROGRAM



After the end of the washing program, the display will indicate that the program has been successfully completed ("Wash finished").



If you have selected the Anti-Crease extra function, gentle tumbling will continue after the end of the washing program in order to prevent creasing.

Open the door towards you and remove the laundry from the washing machine. Make sure the washing machine drum is empty.

If you do not take any action within 5 minutes after the end of the program, the display will switch off to standby mode in order to save power.

The display will light up again if you press the ON/OFF button.

 After the washing cycle, close the water intake and pull out the washing machine plug from the power socket.

SETTINGS

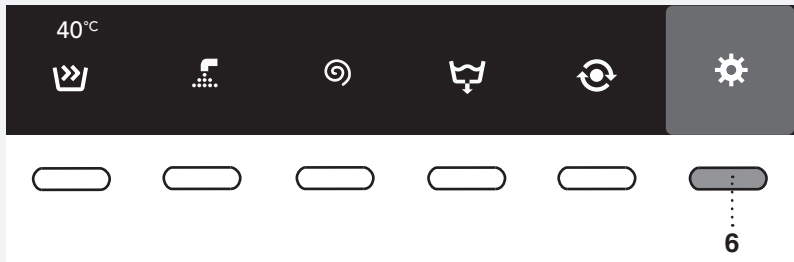

In the Main menu, use the Program selector knob to select Settings. Confirm the selection by pressing the button under the desired setting.

Then, use the Program selector knob to scroll the list of the following settings that you can adjust:



- Child Lock,
- Language (language selection),
- Temperature (temperature unit),
- **Auto Dose System (ADS)**,
- Water (water hardness),
- Sounds (acoustic signals),
- Drum illumination,
- Display: brightness & logo
- Programs (set of programs),
- Reset.

Use the Program selector knob to scroll to the button ← to return to Settings or to the Main menu.

Press the button under the setting to display concise information about the setting.

CHILD LOCK



Select Child Lock with the button.

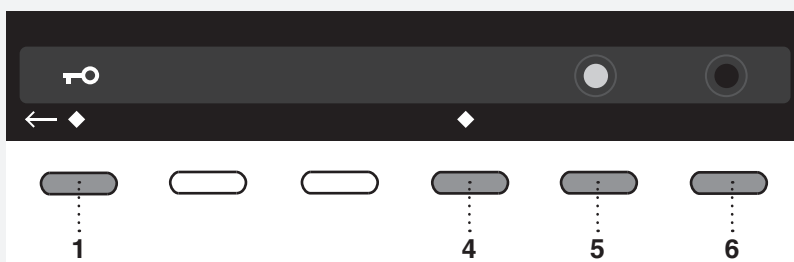

Choose between switching the child lock on or off.

When the child lock is activated, no other function can be selected.

On = Child lock can be activated manually, or it is activated automatically. Manually: press the buttons 1 and 4 and hold them for 3 seconds.

Automatically: activated after 3 minutes. The child lock may only be deactivated manually by pressing the buttons 1 and 4 and holding them for 3 seconds.

Off = The child lock cannot be activated.

Use the ← button to return to Settings.

To temporarily (for 3 minutes) switch off the Child lock, press the 1 and 4 buttons simultaneously and keep them pressed for 3 seconds.

🇬🇧 LANGUAGE



You can choose between 24 languages. Press the 🇬🇧 button. Use the Program selector knob to scroll the list of languages. Confirm selection with button under chosen language.

Use the ← button to return to Settings.

°C/°F TEMPERATURE (TEMPERATURE UNIT)



Choose either °C or °F. Confirm your selection with the button under the selected temperature unit.

Use the ← button to return to Settings.

🧴 AUTOMATIC DOSING SYSTEM (ADS)

For ADS settings, see chapter "SPECIAL FEATURES".



ON = display the ADS menu in the Main Menu

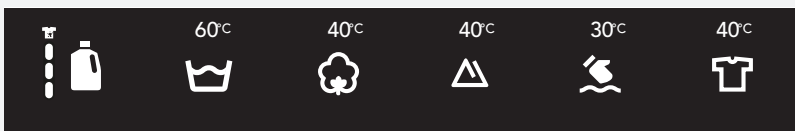

OFF = do not display the ADS menu in the Main Menu

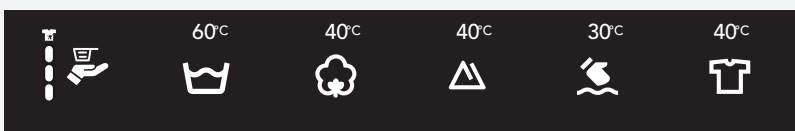

Use the ← button to return to Settings.

WATER (WATER HARDNESS)

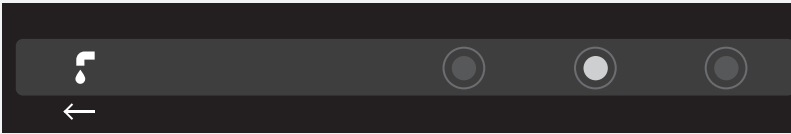

Choose water hardness between the following settings: soft / normal / hard. Confirm your selection with the button under the selected water hardness.

Use the ← button to return to Settings.

Water hardness can be measured with a water hardness indicator (available in a pharmacy). Check the information on water hardness with your local water supply company or authority.

Water hardness	Hardness levels			
	°dH (°N)	m mol/l	°fH(°F)	p.p.m.
1 – soft	< 8,4	< 1,5	< 15	< 150
2 – normal	8,4 - 14	1,5 - 2,5	15 - 25	150 - 250
3 – hard	> 14	> 2,5	> 25	> 250

Water hardness is specified using the following scales: The German water hardness scale (°dH) and the French water hardness scale (°fH).

Contact the local waterworks, or measure the water hardness using the supplied test strip, to check the water hardness in your area.

How to use the test strip:

1. Turn on the water tap and let the water run for a minute or so.
2. Fill a glass with cold water.
3. Remove the test strip from its packaging.
4. Dip the test strip in the water for about one second.
5. Wait one minute. Now compare the colours of the squares with the water hardness table.

Test strip	°dH	°fH
4 green <input type="checkbox"/> <input type="checkbox"/> <input type="checkbox"/> <input type="checkbox"/>	< 3	< 5
1 red <input checked="" type="checkbox"/> <input type="checkbox"/> <input type="checkbox"/> <input type="checkbox"/>	> 4	> 7
2 red <input checked="" type="checkbox"/> <input checked="" type="checkbox"/> <input type="checkbox"/> <input type="checkbox"/>	> 7	> 12
3 red <input checked="" type="checkbox"/> <input checked="" type="checkbox"/> <input checked="" type="checkbox"/> <input type="checkbox"/>	> 14	> 25
4 red <input checked="" type="checkbox"/> <input checked="" type="checkbox"/> <input checked="" type="checkbox"/> <input checked="" type="checkbox"/>	> 21	> 37

SOUNDS

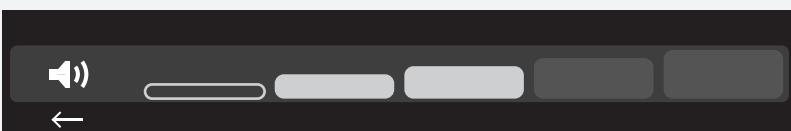

You may choose the acoustic signal volume.

Use the program selector knob or buttons to choose the sound volume. During selection, the acoustic signal will be played with the currently highlighted volume.

Use the ← button to return to Settings.

💡 DRUM ILLUMINATION



Confirm your selection with the button under the drum illumination on/off option.

ON = drum illumination light when the door is open and washing machine is turned on

OFF = drum illumination does not light when the door is open

Use the ← button to return to Settings.

A DISPLAY UNIT



Set the brightness and logo display.



Use the program selector knob or buttons to choose the brightness.



Confirm your selection with the button under the logo display on/off option.

ON = display the logo at turning washing machine on

OFF = not display the logo at turning washing machine on

Use the ← button to return to Settings.

♥ PROGRAMS

The Main menu includes the entire set of programs that you can choose using the Program selector knob. This setting allows only displaying the selected program in the Main menu.

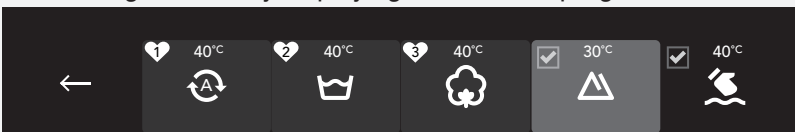

Use the Program selector knob to select a program.

Confirm your selection with the button under the selected program.

Symbol will appear next to the selected program.

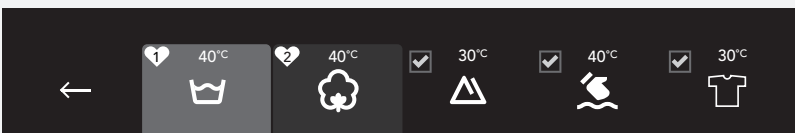

Only programs indicated with will appear on the display unit.

Use the ← button to return to Settings.

🔄 RESET

This means that all settings will return to the default settings and your own settings will be deleted.



Confirm the selection by pressing the button under the "reset" option that will appear on the display.

Use the ← button to return to Settings.

SPECIAL FEATURES

DOSE MODES

1. Display in the Main menu (see chapter "SETTINGS")



Choosing the DOSE MODES in the Main menu.

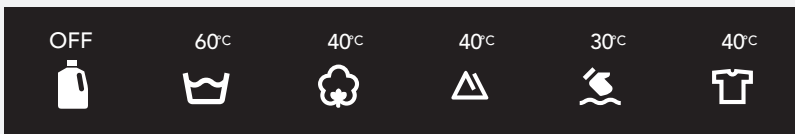

Press the button under icon .

Choose between:

- Dosing detergent from detergent compartment A/B, if you have previously selected **ADS (On)** (see »SETTINGS«).
- Dosing the recommended amount of liquid detergent, if **Dose Assist** is selected . Select dirt level as well ( you can choose between 3 dirt levels)).

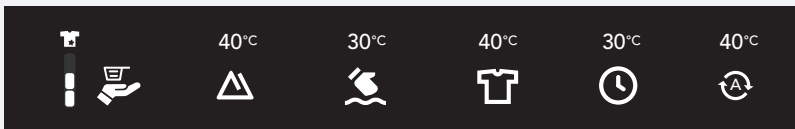

When you select washing program and press Start button, Dose Assist recommends the amount of detergent. (left: concentrated /right: non-concentrated amount of liquid detergent).
Dose recommended amount into detergent compartment and press Start.



Dose Assist can be set for each washing cycle separately.
In some programs the Dose Assist setting is not available.

AUTO DOSE SYSTEM (ADS)

Filling the ADS tank

Choosing the ADS settings by opening the detergent compartment

Switching off the automatic dosing function in the ADS menu

With this setting, you will choose which tank (A or B) the detergent will be dispensed from.

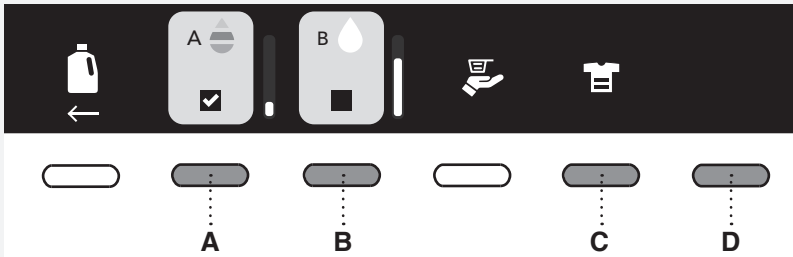

Auto Dose System can be set for each washing cycle separately.

The most recent setting is stored and it can be changed for the next washing cycle.

In some programs the ADS setting is not available.



Press the A/B button and hold if for a while to display information about the content of the A/B tank.

A, B. Choose the compartment from which the detergent is to be added depending on the type of laundry. You can choose between automatic detergent dosing from compartment A or from compartment B. Confirm the setting with . Before choosing compartment A or B, you must fill the compartment with liquid detergent.

 Liquid detergent for Colour

 Liquid detergent for Black / White / Sensitive / Other. See section D/e (choosing the type of laundry).

C. Choose how heavily soiled the laundry is. Choose between:

	Lightly soiled laundry
	Normally soiled laundry
	Heavily soiled laundry

The washing program will choose the suitable amount of detergent depending on the setting for how heavily the laundry is soiled.

D. Press the Options button to set the following:

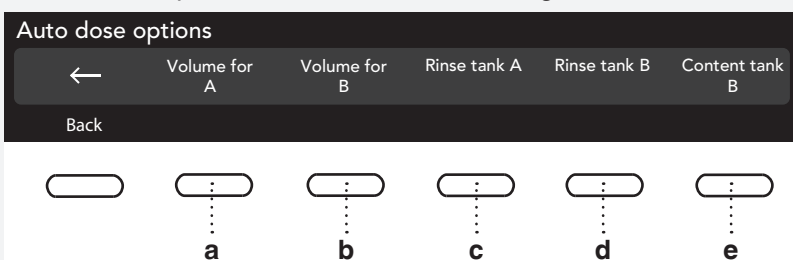

a, b. Amount of liquid detergent (ml/cycle from the compartment, A or B. Choose the amount of detergent according to liquid detergent manufacturer's recommendations specified on the packaging. For this washing machine model, observe the recommendations for 4–6 kg loads, medium water hardness and medium-soiled laundry. The washing machine's factory setting is 50 ml. This amount will be adjusted depending on the water hardness setting, load sensed by the washing machine, and how heavily the laundry is soiled.

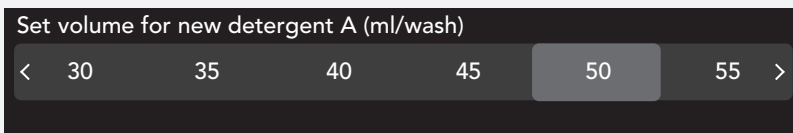
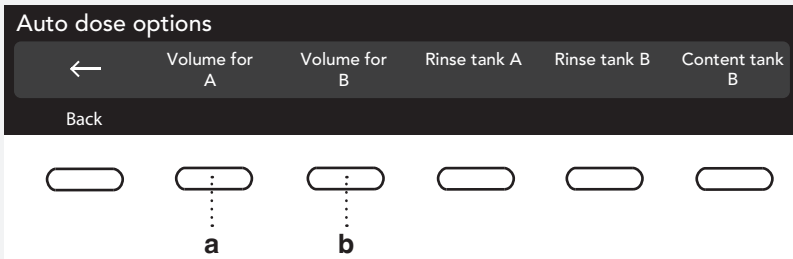

c, d. Cleaning the detergent tank

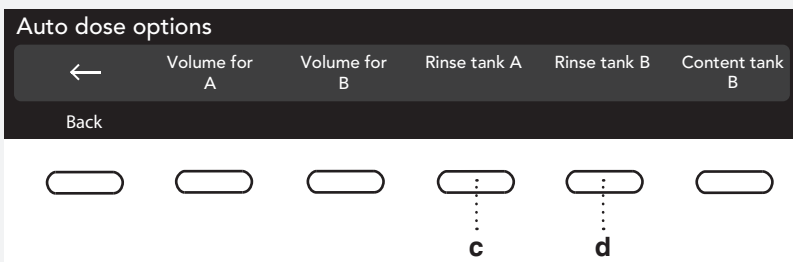

Select Options, then choose Rinse.

We recommend cleaning the detergent tank once per two months and when it is empty. Before cleaning the detergent tank, close the detergent compartment.

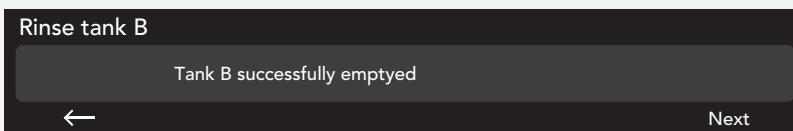
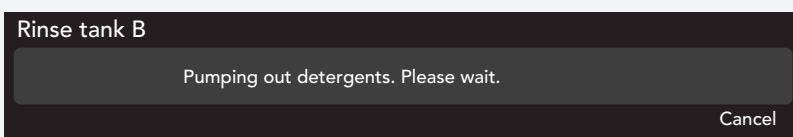

The compartment may be additionally rinsed with an extra amount of water via detergent compartment inlet. (500 ml of water). Open the detergent compartment to the final position and add water to the compartment to be cleaned. Then, close the detergent compartment and press the **Start** button ► (maximum amount of detergent that can be added to selected detergent tank is 1.5 l)

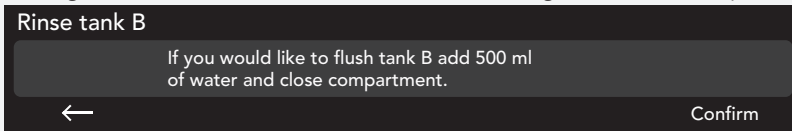

If you do not wish to rinse the tank with water, the process can be cancelled by pressing ← button.

If you have already started supplying the water, the process can no longer be cancelled. The ← sign will disappear and the water filling process has to be completed.

When cleaning of compartment B is completed, open the detergent compartment to the end position and pour the liquid detergent into compartment B.

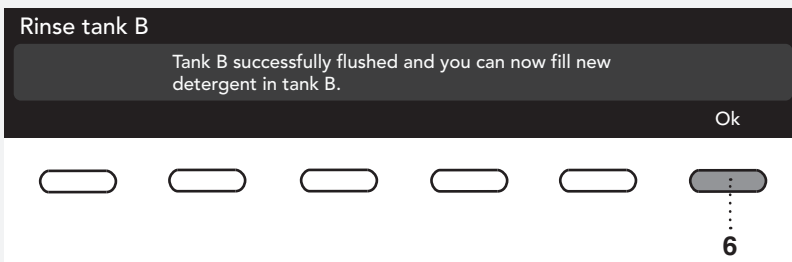

💡 Cleaning time for a full tank (draining + rinsing) may be up to 60 minutes.

e. Type of detergent, and changing the detergent in the ADS

The detergent in the compartment A shall only be used for one type of laundry: coloured wash (Colour). The detergent in compartment B shall be designated for several types of laundry:

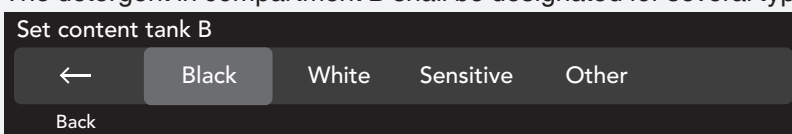

When you change the detergent in the tank B, select another type of laundry. The question whether you are sure you wish to change the detergent will appear on the display unit.

💡 We recommend changing the detergent when the detergent tray is empty.

Otherwise, the compartment has to be emptied. In this case, however, the detergent compartment has to be closed first.

Pour the other type of liquid detergent into compartment B (e.g. if you have selected Black, you will probably add the special detergent for black laundry).

💡 If the compartment is not empty, then the liquid detergent should be pumped out from the compartment and the compartment should be cleaned (see section c, d. "Cleaning the compartments").

Filling the compartment with liquid detergent

💡 Before adding the liquid detergent into the tank, pull out the detergent compartment as far as it will go. (If the detergent compartment is not fully opened, the liquid detergent will not flow into the tank.)

💡 The washing machine has to be switched on.

💡 Please do not fill detergent (liquid detergent) while program is running!

Start adding the liquid detergent to the selected compartment. The level for the selected compartment, indicated on the display unit, will increase. When the compartment is full, stop adding the detergent. (maximum amount of detergent that can be added to selected compartment is 1.5 l).

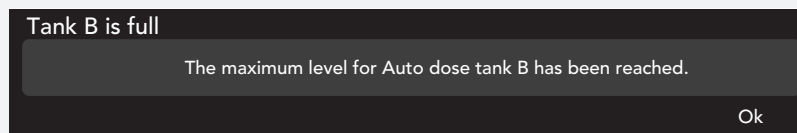

💡 Before closing the dosing tank, wait for 1 minute to let the detergent flow into the compartment.

If you add too much liquid detergent, it may overflow into the washing machine drum. To remove the detergent from the drum, use the Rinse program.

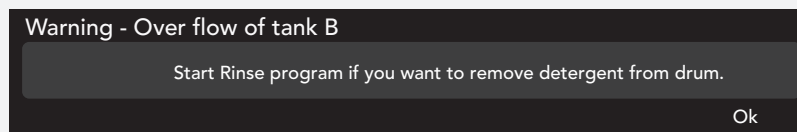

Choosing the ADS settings by opening the detergent compartment



Pull out the detergent compartment as far as it will go, to its end position! The ADS setting in the Main Menu will be displayed.

All steps are the same as with section 2 (Choosing the ADS settings in the Main menu).

💡 If you selected OFF in the Settings (i.e. do not display the ADS menu in the Main Menu), then the ADS menu will not be displayed when you open the detergent compartment.

💡 Only add liquid detergents into the ADS tanks.

💡 Do not mix liquid detergent with conditioner. Do not add conditioner into any ADS tank; conditioner has to be added **manually** to the compartment labelled with ☼.

💡 Do not mix different liquid detergents. Before changing the liquid detergent (depending on the type of laundry), the tanks have to be cleaned. See sections c, d. Cleaning the tanks.

Switching off the automatic dosing function in the ADS menu

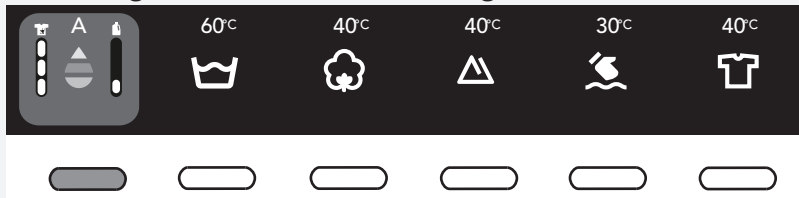

Press the button under the ADS in the Main Menu.

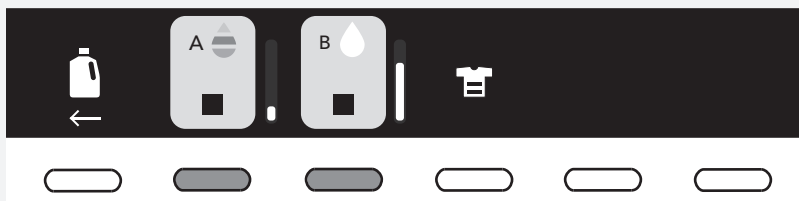

Tanks A and B should not be checked (no check mark in the square). Thus, the system will not automatically dose the detergent. Liquid detergent has to be added manually into the detergent compartment.

CLEANING AND MAINTENANCE

CLEANING THE FILTER

The washing machine has a filter that will retain smaller objects such as coins, buttons, hair etc.

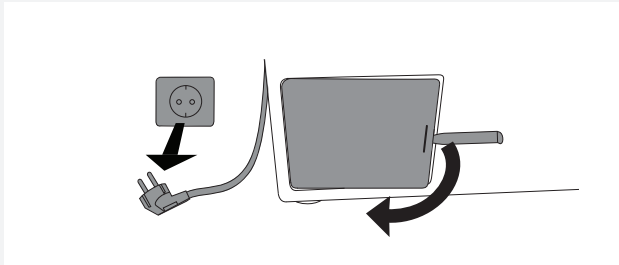

1 Before cleaning, drain the water from the washing machine using the Drain program, and disconnect the washing machine from the power mains.

Open the pump filter cover using appropriate tools (emergency door opening tool is located on the back side of the dispenser).

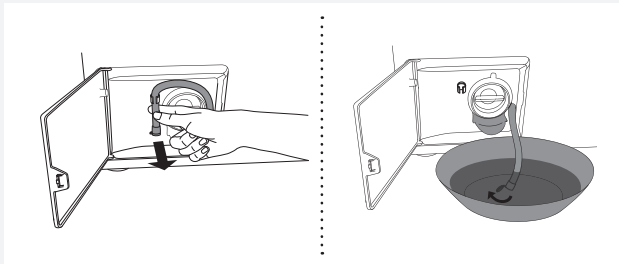

2 Release the water drain hose from the holder.

Before cleaning the filter, drain the water from the washing machine by placing the end of the water drain hose over a large shallow container and opening the cap on the water drain hose.

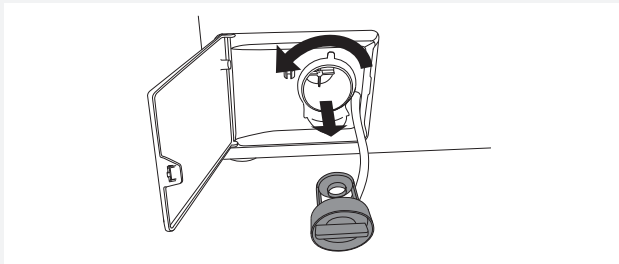

3 Gradually rotate the filter in the counter-clockwise direction and pull it out.

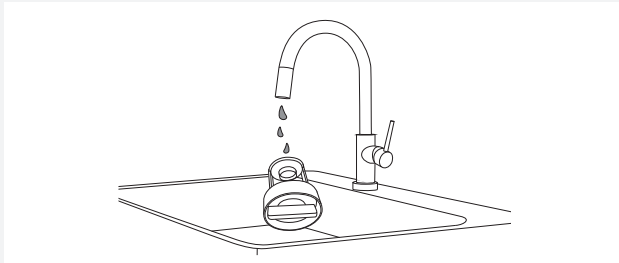

4 Clean the filter thoroughly under running water.

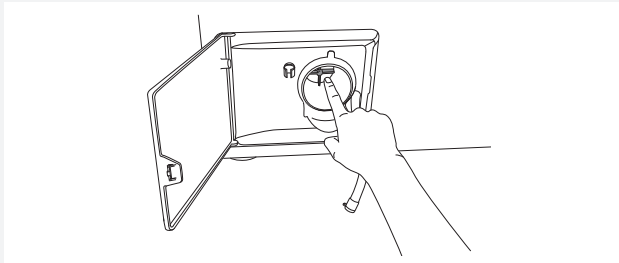

5 Remove all objects and impurities from the filter housing and the impeller.

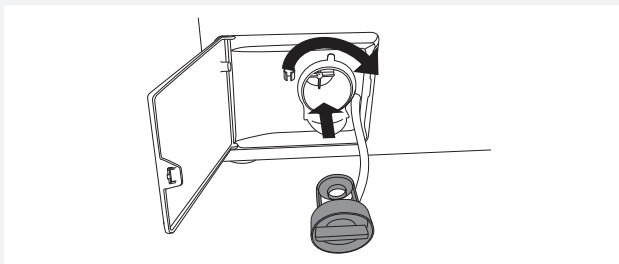

6 Replace the filter as shown in the figure and fasten it by rotating in the clockwise direction. For a good seal, the filter seal surface should be clean. Also re-install the drain hose.

CLEANING THE DETERGENT COMPARTMENT AND DOOR RUBBER GASKET

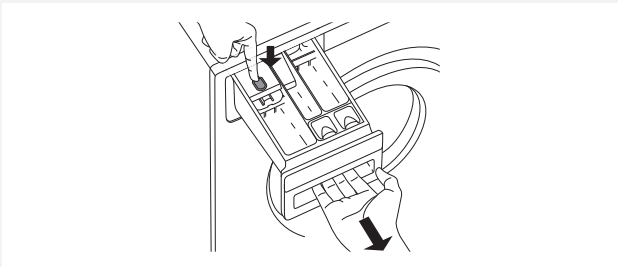

1 Press the tab to completely remove the detergent compartment from its housing.

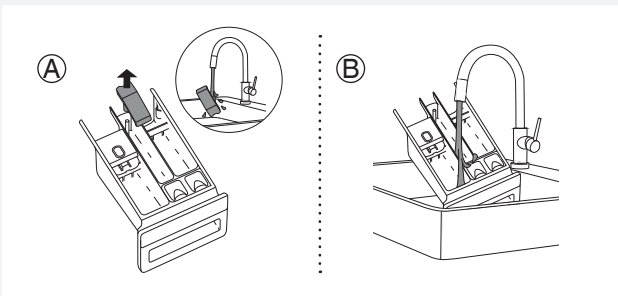

2 Rinse and thoroughly clean the tray. You may also remove the cap from the plug in the conditioner compartment (A). Clean any residue from the cap and tube.

Clean the detergent compartment (B) interior.

Replace the cap on the plug.

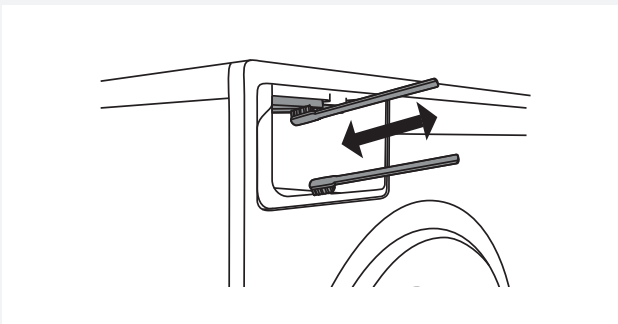

3 Use a brush to clean the nozzles on the upper side of the detergent compartment housing.

After a washing program, nozzles that clean the interior of the dispenser are automatically switched on (only available in some models).

Use a brush to clean the lower part of the detergent compartment housing.

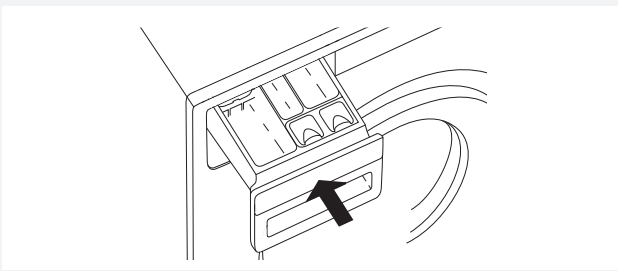

4 Replace the detergent dispenser into its housing.

💡 Close the detergent compartment!

💡 Do not wash the detergent compartment in the dishwasher!

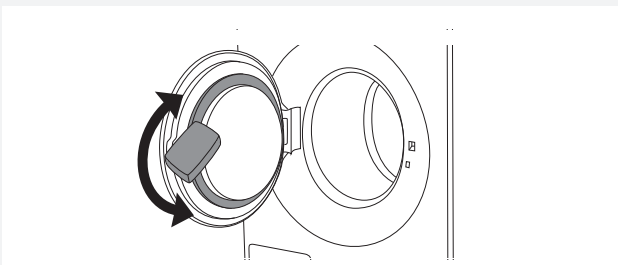

5 After every wash, wipe the rubber door seal to extend its useful life.

CLEANING THE AUTO DOSE SYSTEM (ADS)

Cleaning the detergent compartment:

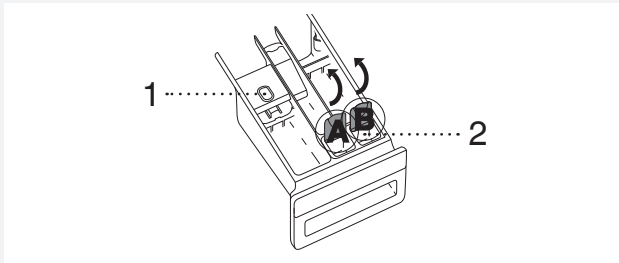

1 Remove the detergent compartment from the dispenser housing by pulling it out and pressing the release tab (1).

Open the cover for detergent compartment A and B (2).

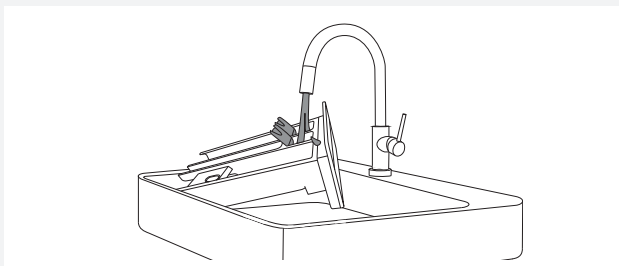

2 Rinse the detergent compartment by directing a stream of running water through it.

CLEANING THE APPLIANCE EXTERIOR

Clean the appliance exterior and the display unit using a soft damp cotton cloth and water.

Do not use solvents or abrasive cleaners that could damage the appliance (please observe the recommendations and warnings provided by the manufacturers of the cleaning agents).

 Do not clean the washing machine with a jet of water!

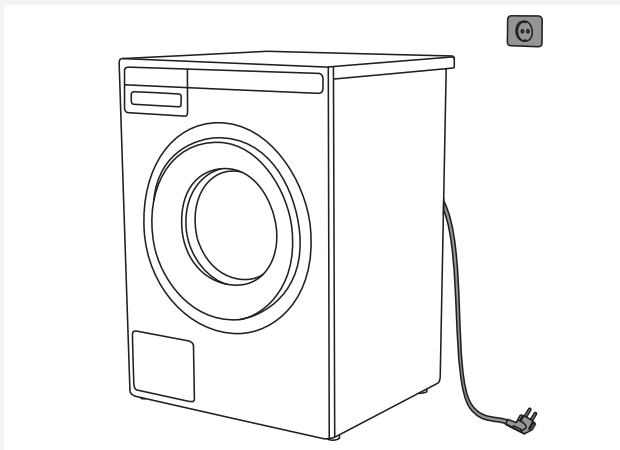

 Always disconnect the washing machine from the power mains before cleaning.

CLEANING THE WASHING MACHINE INTERIOR AGAINST ODOURS

Modern detergents often allow washing clothes at low temperatures. This means that residue may accumulate in the washing machine, which in turn could cause odours.

To avoid such odours, we recommend running the self-cleaning program (Drum-cleaning) once per month. The drum has to be empty.

CLEANING THE RINSING HOLES (UNDER THE AGITATOR IN THE DRUM)

If you believe that objects like nails or paper clips fell into the washing machine drum, check the area underneath the agitator. Such objects may rust (corrode) and cause stains on your clothes. Nails and other sharp objects can also cause holes in the fabric.

Proceed as follows:



- 1 Insert a screwdriver or a similar tool into the slot in the rib and carefully push it to the left.



- 2 Hold the rib with the other hand and pull it towards you.

- 3 Lift the drum rib.

- 4 Remove any objects.

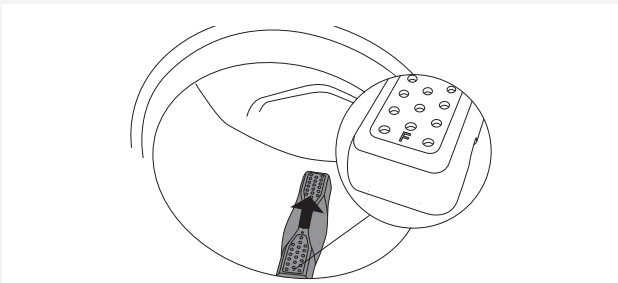

- 5 Place the rib into the installation slot indicated with "F" towards you. Make sure all ribs are firmly in place in their respective slots in the drum. Push the rib inwards (as indicated by the arrow in the figure) until it snaps.

If you are using hard water

If you are washing with hard water (causing limescale build-up), a greyish-white film may appear on the washing machine drum. To remove this film, add vinegar (approximately 2 dl or sodium bicarbonate "baking soda" (1 tablespoon or 15 g)) into the washing machine drum and select any program with a temperature of 90 °C, or the Drum Cleaning program. See STEP 5: Choose the program.

Repeat the process as necessary.

Water hardness can be set under "SETTINGS / Water / Water Hardness".

ERRORS – WHAT TO DO?

Disturbances from the environment (e.g. the power grid) may result in various error reports (see Troubleshooting table). In such case:

- Switch off the appliance, wait for 1 minute, switch the appliance back on, and repeat the washing program.
- If the error persists, call an authorized service unit.
- You will be able to solve most of the **problems** in appliance operation by yourself (see Troubleshooting table below).
- **Repairs** may only be carried out by an adequately trained person.
- Repair or any warranty claim resulting from incorrect connection or use of the washing machine shall not be covered by the warranty. In such cases, the costs of repair shall be charged to the user.

 The warranty does not cover the errors or failures resulting from disturbances from the environment (lightning strike, power grid failures, natural disasters etc.).

Problem/error	Cause	What to do?
Washing machine door does not open.	• Water level too high.	• Drain the water using the Drain or Spinning program. See "Step 5: Choose the program".
	• Water temperature in the washing machine is too high.	• Wait for the water temperature to drop and pump out the water. If you still cannot open the door, use the emergency door opening tool (see chapter "ERRORS – WHAT TO DO? / Manual opening of washing machine door").
Washing program is not in progress.	• Washing machine door is not properly closed.	• Firmly press on the washing machine door until you hear two clicks when it is closed.
	• There is no voltage in the power outlet.	• Check if the plug is connected to the power outlet and whether there is electric current (or voltage) in the outlet.
	• Delayed start function has been selected.	• To cancel the delayed start function, press the Start ▶ button and hold it for three seconds.
Washing time is longer than anticipated (the time is regularly updated on the display unit).	• Low inlet water temperature.	• Program duration can be up to 60% longer than initially anticipated in the normal progress.
	• UKS* (*unbalance system) stability system engaged due to unevenly distributed laundry.	• Program time is extended due to the need to redistribute the laundry in the drum.
	• Low mains voltage.	• Washing machine needs more time because the power mains voltage is too low.
	• Power supply failure.	• Program time is extended by the duration of the power supply failure.
Display does not light up.	• There is no voltage in the appliance.	• Check if the plug is connected to the power outlet and whether there is electric current (or voltage) in the outlet.
The wording on the display unit is not in your language.	• You have not selected your preferred language yet.	• Choose the preferred language (see "STEP 5 / Settings / Choosing the language").
Wet laundry ("unbalance" will appear on display)	• A small amount of laundry will often be unevenly distributed.	<ul style="list-style-type: none"> • Loosen and redistribute the laundry and select the Drain or Spinning program. • Increase the amount of laundry in the washing machine and restart the program (see "STEP 7: Start the wash / Adding or removing laundry after the start of the program").

Problem/error	Cause	What to do?
There are traces of grease (or grease rolls) on the clothes.	<ul style="list-style-type: none"> • The laundry was very greasy. 	<ul style="list-style-type: none"> • Wash the laundry again. When your laundry is this heavily soiled, add more washing powder or use a liquid detergent in combination with a more powerful (longer) program.
There are still stains on the laundry.	<ul style="list-style-type: none"> • You used bleach-free liquid detergent or powder detergent for coloured laundry. 	<ul style="list-style-type: none"> • Use a detergent that contains bleach.
	<ul style="list-style-type: none"> • You selected an unsuitable program. 	<ul style="list-style-type: none"> • Use special stain removers.
There are white residues of washing powder on the laundry.	<ul style="list-style-type: none"> • This is not due to poor rinsing by your washing machine, but rather due to phosphate-free detergents which contain ingredients (zeolites) for water softening. These ingredients may be deposited on the laundry. 	<ul style="list-style-type: none"> • Immediately rinse the laundry again. • Use liquid detergents that do not contain zeolites. • Try removing any residues with a brush.
There is powder detergent left in the main wash compartment of the detergent compartment.	<ul style="list-style-type: none"> • Water pressure not high enough. 	<ul style="list-style-type: none"> • Clean the net on the water supply hose.
	<ul style="list-style-type: none"> • Some washing powders may stick strongly to the detergent compartment if it is empty. 	<ul style="list-style-type: none"> • Choose higher water level or extra rinse (see "Step 6 / Choose program settings"). • Wipe the detergent compartment before adding the powder detergent.
There is conditioner left in the conditioner compartment of the detergent compartment.	<ul style="list-style-type: none"> • Plug cap is not positioned correctly or it is clogged. 	<ul style="list-style-type: none"> • Make sure the plug cap in the conditioner compartment of the detergent compartment is positioned correctly. • Clean the plug cap (see chapter "CLEANING AND MAINTENANCE / Cleaning the detergent compartment").
Odour in the washing machine drum.	<ul style="list-style-type: none"> • Residues of fabric, washing detergent, and conditioner in the filter. 	<ul style="list-style-type: none"> • Check if the filter is clean.
	<ul style="list-style-type: none"> • Development of germs and bacteria. 	<ul style="list-style-type: none"> • Choose a self-cleaning (Drum Cleaning) program (see "STEP 5: Choose the program").
Machine is moving during operation.	<ul style="list-style-type: none"> • Feet not adjusted correctly. 	<ul style="list-style-type: none"> • Level the feet (see chapter "INSTALLATION AND CONNECTION / Adjusting the feet").
	<ul style="list-style-type: none"> • Transport bolts not removed. 	<ul style="list-style-type: none"> • Remove the transport bolts (see chapter "BEFORE USING THE APPLIANCE FOR THE FIRST TIME / Transport protection").
Machine is moving during spinning.	<ul style="list-style-type: none"> • Unevenly distributed laundry or not enough laundry. 	<ul style="list-style-type: none"> • The washing machine will automatically decrease the spin speed if vibration is too strong. • Increase the amount of laundry in the washing machine and restart the program (see "STEP 7: Start the wash / Adding or removing laundry after the start of the program").
Noisy (loud) drain pump	<ul style="list-style-type: none"> • Drain pump filter is clogged. • Filter housing and drain pump impeller are clogged. 	<ul style="list-style-type: none"> • Make sure the drain pump filter is clean. • Make sure the filter housing is clean. (See chapter "CLEANING AND MAINTENANCE/ Cleaning the filter")

Manual opening of washing machine door

 Washing machine door may be opened **manually** if the appliance is not connected to the power mains and if the water has been pumped out of the machine.

- A Choose the Spinning or Drain program to pump the water from the machine. If this does not work, water has to be drained from the washing machine drum manually. See chapter "Cleaning the trap and drain pump" in the chapter "CLEANING AND MAINTENANCE".
- B Make sure the main switch is off and that the plug is disconnected from the power outlet.
- C Take the emergency door opening tool (found at the back of the detergent compartment) and insert it into the upper part of the slot on the right-hand side of the washing machine door latch.

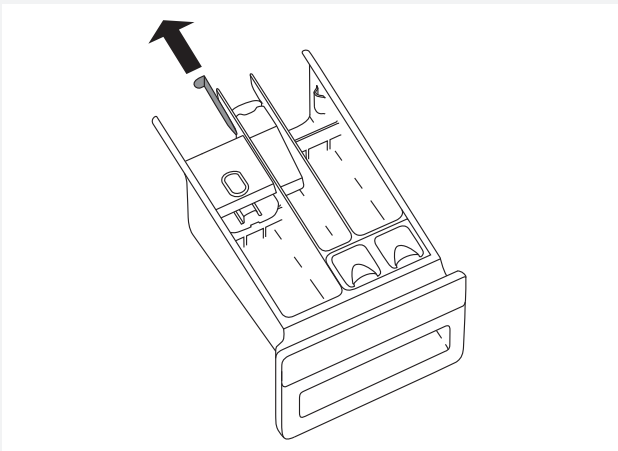

- D Press the key (key=the emergency door opening tool) downwards (all the way, until you hear a click) to unlock the washing machine door. When the door is unlocked, open it by pulling towards you.

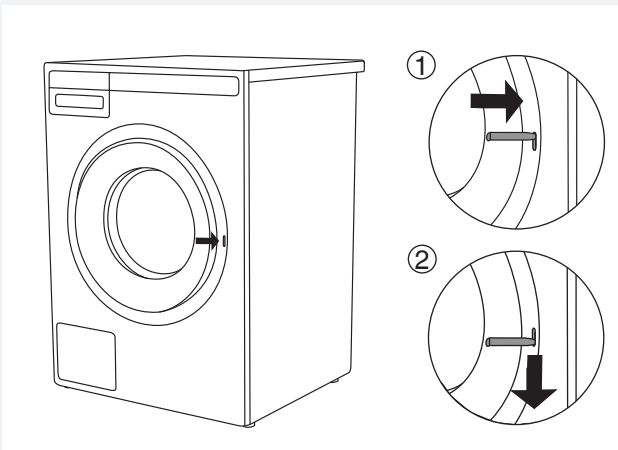

 If the washing machine door still cannot be opened, call a service technician.

FAILURE DISPLAY

In case of a failure while a program is in progress, the relevant Error XX is indicated on the display unit.

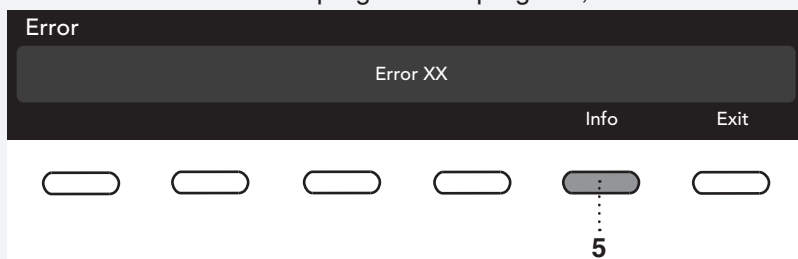

Press the INFO button to display the error description.

Switch off the appliance and turn it back on.

Errors indicated on the display unit may include the following:

Error	Error indication on the display unit	What to do?
E0	INCORRECT SETTINGS	Restart the programme. If the error reoccurs, call a service technician.
E1	THERMISTOR ERROR Temperature sensor error.	<ul style="list-style-type: none"> • Inlet water too cold. Repeat the washing program. • If the appliance reports this error again, call a service technician.
E2	DOOR LOCK ERROR	Turn the appliance OFF and then switch it again ON. Start the program again. If the error reoccurs, call service technician.
E3	WATER FILLING ERROR	<p>Check the following:</p> <ul style="list-style-type: none"> • is the water inlet valve open, • is the filter on the water inlet hose clean, • is the water supply hose deformed (clipped, clogged etc.), • is the pressure in the water mains between 0.1 and 1 MPa (1–10 bar). <p>Then, press the Exit button to resume the program. If the error reoccurs, call a service technician.</p>
E6	HEATING ERROR Water heating error.	Restart the program. If the error reoccurs, call a service technician.
E7	DRAINING ERROR Water draining error.	<p>Check the following:</p> <ul style="list-style-type: none"> • is the pump filter clean, • is the drain hose clogged, • is the drain clogged, • is the drain hose fitted at the right height (see chapter on drain hose installation in the instruction manual). <p>Then, press the Exit button again. If the error reoccurs, call a service technician.</p>
E8	SPINNING ERROR	Turn the appliance OFF and then switch it again ON. Start the program again. If the error reoccurs, call service technician.
E10	WATER LEVEL SENSOR ERROR	Turn the appliance OFF and then switch it again ON. Start the program again. If the error reoccurs, call service technician.
E11	OVERFLOW	<p>If there is water in the drum that exceeds a certain level, and an error is reported on the display unit, the washing program will be interrupted and water will be pumped out of the washing machine. Restart the programme. If the error reoccurs, call a service technician.</p> <p>If there is water in the drum that exceeds a certain level, and an error is reported on the display unit, while the washing machine continues to add water, close the water tap and call a service technician.</p>
E12	MOTOR ERROR / MOTOR CONTROL ERROR	Restart the program. If the error reoccurs, call a service technician.

Error	Error indication on the display unit	What to do?
E13.1	UNBALANCE EMPTY DRUM	Call a service technician.
E13.2	INERTIA ERROR	Call a service technician.
E23	DOOR UNLOCK ERROR Error while unlocking the door.	Door is closed, but it cannot be unlocked. Turn off the washing machine, then turn it back on. If the error reoccurs, call a service technician. See instructions for opening the door – chapter on manual door opening.
E29	REED SWITCH 1 ERROR	Call a service technician.
E30	REED SWITCH 2 ERROR	Call a service technician.
E31	PERISTALTIC PUMP 1 ERROR	Call a service technician.
E32	PERISTALTIC PUMP 2 ERROR	Call a service technician.
E33	AD1 DETERGENT LEVEL SENSOR ERROR	Restart the programme. If the error reoccurs, call a service technician.
E34	AD2 DETERGENT LEVEL SENSOR ERROR.	Restart the programme. If the error reoccurs, call a service technician.
E35	COMMUNICATION AD AND PMCU	Turn off the appliance and turn it back on. If the error reoccurs, call a service technician.
E36	COMMUNICATION UI** AND PMCU Error in UI** and PMCU communication.	Turn off the appliance and turn it back on. If the error reoccurs, call a service technician.
E37	PMCU/UI** software versions are not compatible.	Call a service technician.
	UNBALANCE Unevenly distributed laundry.	Manually distribute the laundry and run the spinning program.
	UNABLE TO LOCK DOOR	Open and firmly close the door again to final position. If the error reoccurs, call a service technician.
	STERIL TUB ALERT Warning – Self-cleaning program	Message "Sterile Tube alert" is displayed every 40 completed wash cycles. Use the self-cleaning program (DRUM CLEANING); see STEP 5.
	Preparing to door unlocking. (press INFO): Draining must be performed. Wait for door unlocking.	Wait that process is finished. If after this process no error is shown, new cycle can be run.
	DRAIN SYSTEM ALERT	Alert about reduced water flow in the pumping stage. Please check user manuals.

** UI = (User Interface)

Unevenly distributed laundry or lumps of laundry in the washing machine drum may cause problems such as vibration and noisy operation. The washing machine will sense this and activate the UKS* (*unbalance system).
Smaller loads (e.g. one towel, one sweater, one bathrobe etc.) or clothes made of materials with special geometrical properties are virtually impossible to distribute evenly across the washing machine drum (slippers, large items etc.). This results in several attempts to redistribute the laundry, which in turn leads to longer program duration. In extreme cases of unfavourable conditions, the program can be completed without the spinning cycle.
UKS* (*unbalance system) allows stable operation and extends the useful life of the appliance.

SERVICE

BEFORE CALLING A SERVICE TECHNICIAN

When you contact a service centre, please state the model (1), type (2), and serial number (3) of your washing machine.

Model, type, and serial number are indicated on the rating (type) plate located on the washing machine door casing.

⚠ In case of a failure, only use approved spare parts by authorized manufacturers.

⚠ Repair or any warranty claim resulting from incorrect connection or use of the washing machine shall not be covered by the warranty. In such cases, the costs of repair shall be charged to the user.

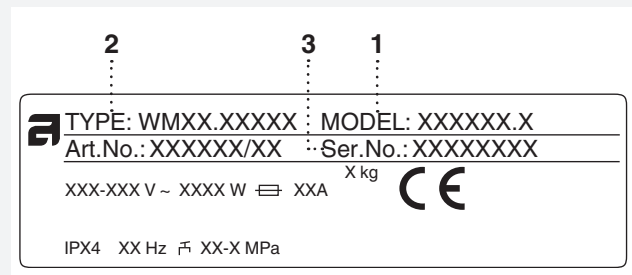

TECHNICAL INFORMATION

PRODUCT INFORMATION SHEET ACCORDING TO EU-REGULATION NO. 2019/2014
(depending of model)

Supplier's name or trade mark:					
Supplier's adress ^(b):					
Model identifier:					
General product parameters:					
Parameter	Value		Parameter	Value	
Rated capacity ^(a) (kg)	9,0		Dimensions in cm	Height	85,0
				Width	59,5
				Depth	58,5
EEI _w ^(a)	57,9		Energy efficiency class ^(a)	[A/B/C/D/E/F/G] ^(c)	
Washing efficiency index ^(a)	1,04		Rinsing effectiveness (g/kg) ^(a)	3,7	
Energy consumption in kWh per cycle, based on the »eco 40-60« programme. Actual energy consumption will depend on how the appliance is used.	1,000		Water consumption in litre per cycle, based on the »eco 40-60« programme. Actual water consumption will depend on how the appliance is used and on the hardness of the water.	64	
Maximum temperature inside the treated textile ^(a) (°C)	Rated capacity	39	Remaining moisture content ^(a) (%)	Rated capacity	43
	Half	28		Half	43
	Quarter	27		Quarter	43
Spin speed ^(a) (rpm)	Rated capacity	1800	Spin-drying efficiency class ^(a)	[A/B/C/D/E/F/G] ^(c)	
	Half	1800			
	Quarter	1800			
Programme duration ^(a) (h:min)	Rated capacity	3:30	Type	[built-in/ free standing]	
	Half	2:50			
	Quarter	2:50			
Airborne acoustical noise emissions in the spinning phase ^(a) (dB(A) re 1 pW)	76		Airborne acoustical noise emissions class ^(a) (spinning phase)	[A/B/C/D] ^(c)	
Off-mode (W)	0,30		Standby mode (W)	0,30	
Delay start (W) (if applicable)	/		Networked standby (W) (if applicable)	/	
Minimum duration of the guarantee offered by the supplier ^(b): 2 years					
This product has been designed to release silver ions during the washing cycle			[YES/NO]		

Additional information:

Weblink to the supplier's website, where the information from point 9 Annex II to Commission Regulation (EU) 2019/2023 ^(a) ^(b) is found:

^(a) for the »eco 40-60« programme.

^(b) changes to these items shall not be considered relevant for the purposes of paragraph 4 of Article 4 of Regulation (EU) 2017/1369.

^(c) if the product database automatically generates the definitive content of this cell the supplier shall not enter these data.

PRODUCT INFORMATION SHEET ACCORDING TO EU-REGULATION NO. 2019/2014
(depending of model)

Supplier's name or trade mark:					
Supplier's adress ^(b):					
Model identifier:					
General product parameters:					
Parameter	Value		Parameter	Value	
Rated capacity ^(a) (kg)	9,0		Dimensions in cm	Height	85,0
				Width	59,5
				Depth	58,5
EEI _w ^(a)	51,8		Energy efficiency class ^(a)	[A/B/C/D/E/F/G] ^(c)	
Washing efficiency index ^(a)	1,035		Rinsing effectiveness (g/kg) ^(a)	4,3	
Energy consumption in kWh per cycle, based on the »eco 40-60« programme. Actual energy consumption will depend on how the appliance is used.	0,490		Water consumption in litre per cycle, based on the »eco 40-60« programme. Actual water consumption will depend on how the appliance is used and on the hardness of the water.	49	
Maximum temperature inside the treated textile ^(a) (°C)	Rated capacity	38	Remaining moisture content ^(a) (%)	Rated capacity	43
	Half	20		Half	43
	Quarter	20		Quarter	43
Spin speed ^(a) (rpm)	Rated capacity	1800	Spin-drying efficiency class ^(a)	[A/B/C/D/E/F/G] ^(c)	
	Half	1800			
	Quarter	1800			
Programme duration ^(a) (h:min)	Rated capacity	3:30	Type	[built-in/ free standing]	
	Half	2:51			
	Quarter	2:51			
Airborne acoustical noise emissions in the spinning phase ^(a) (dB(A) re 1 pW)	77		Airborne acoustical noise emissions class ^(a) (spinning phase)	[A/B/C/D] ^(c)	
Off-mode (W)	0,30		Standby mode (W)	0,30	
Delay start (W) (if applicable)	/		Networked standby (W) (if applicable)	/	
Minimum duration of the guarantee offered by the supplier ^(b): 2 years					
This product has been designed to release silver ions during the washing cycle			[YES/NO]		

Additional information:

Weblink to the supplier's website, where the information from point 9 Annex II to Commission Regulation (EU) 2019/2023 ^(a) ^(b) is found:

^(a) for the »eco 40-60« programme.

^(b) changes to these items shall not be considered relevant for the purposes of paragraph 4 of Article 4 of Regulation (EU) 2017/1369.

^(c) if the product database automatically generates the definitive content of this cell the supplier shall not enter these data.

PERFORMANCE DATA

Program	Maximum load	Temp. °C
Eco 40-60 ¹⁾	9 / 4,5* / 2,5** kg	
Universal wash ²⁾	9 / 4,5* kg	60
Mix/Synthetics ²⁾	3,5 kg	40

¹⁾ PRODUCT INFORMATION SHEET According to EU-Regulation No. 2019/2014

²⁾ 40 °C program for testing institutes. The 40 °C option has to be set.

* Half load

** Quarter load

ENERGY LABELLING

European test standard	¹⁾
Washing program	9 kg cotton Eco 40-60 ¹⁾
Connection	Cold water 15 °C
Noise testing method	IEC-60704-2-4

TECHNICAL INFORMATION

Height	850 mm
Width	595 mm
Depth	585 mm
Weight	88,5 kg
Drum volume	60 l
Rated power	See rating plate
Heater power	See rating plate
Water pressure	0,1–1 MPa 1–10 kp/cm ² 10–100 N/cm ²
Material for the drum and dispenser	Stainless steel
Housing material	Hot-dip galvanized and powder coated sheet metal, or stainless steel sheet (depending on model)
Water connection	1.5 m pex hose
Drain hose	1.6 m polypropylene hose

PROGRAM TABLE

Program	Prewash	Temp. °C	Super rinse	Agitation level**	Spinning speed (rpm)	Residual moisture [%]	Maximum load (kg)	Water consumption (approximately, in litres)	Power consumption (approximately, kWh)	Program duration (approximately, in hours and minutes)
Universal wash	X	60 ²⁾	X	I/N	1800		9	80	2,10	2:26
Cotton	X	40/20	X	N	1800		9	78	1,80	2:59/1:33
Eco 40-60 ¹⁾					1800	43	9	64	1,00	3:30
Mix/Synthetics	X	40 ²⁾	X	N/S	1200		3,5	60	0,60	1:54
Wool/Hand wash	X	30	X	H	800		2	58	0,28	0:52
Dark wash	X	40	X	E	1200		3	40	0,53	1:15
Time program	X	30		E	1000		2	-	-	-
Auto program	X	40	X	N	1800		9	-	-	-
Quick program	X	❄	X	N	1600		9	40	0,50	0:30
Heavy	X	60	X	I	1800		9	100	2,50	2:46
Easy care	X	40	X	N/S	1200		3,5	60	0,65	1:57
Jeans	X	40	X	E	1200		3,5	50	0,60	1:18
Shirts	X	40	X	E	1200		3,5	45	0,45	1:09
Steam Refresh					-	-	1,5	-	-	0:20
Quick Pro	X	40	X	N	1200		4	40	0,50	0:59
Hygiene	X	60	X	I	1800		5	87	1,80	2:27
Sports wear	X	40	X	E	1200		3,5	43	0,40	0:55
Conditioning			X		1200		3,5	15	0,03	0:23
Stain program	X	40	X	I	1800		9	-	-	-
Bedding	X	60	X	N	1800		4	52	1,67	2:15
Allergy program cotton	X	60	X	I	1800		9	95	1,85	2:43
Allergy program synthetics	X	60	X	N/S	1200		4	70	1,10	2:32
Rinse			X	N	1800		3,5	30	0,06	0:29
Spin				-	1800		9	-	0,06	0:17
Drain				-			9	-	0,01	0:01
Drum cleaning				S				-	-	-

❄ Cold wash

**Agitation level (I = Intensive rhythm, N = Normal rhythm, E = Extra sensitive rhythm, S = Sensitive rhythm, H = Hand wash rhythm)

¹⁾ PRODUCT INFORMATION SHEET According to EU-Regulation No. 2019/2014

²⁾ 40 °C program for testing institutes. The 40 °C option has to be set.

The above table includes several examples of the use of energy, water, and time for several different program settings. Actual consumption or duration may vary depending on the water pressure, water hardness, water inlet temperature, room temperature, weight and type of load, changes in power supply, and selected options or settings. In the examples specified here, the draining is set to Normal and no additional options are selected.

Maximum or nominal load applies to laundry prepared pursuant to the IEC 60456 standard.

W6098X/3

Program	Prewash	Temp. °C	Super rinse	Agitation level**	Spinning speed (rpm)	Residual moisture [%]	Maximum load (kg)	Water consumption (approximately, in litres)	Power consumption (approximately, kWh)	Program duration (approximately, in hours and minutes)
Universal wash	X	60 ²⁾	X	I/N	1800		9	80	2,10	2:26
Cotton	X	40/20	X	N	1800		9	78	1,80	2:59/1:33
Eco 40-60 ¹⁾					1800	43	9	62	1,00	3:30
Mix/Synthetics	X	40 ²⁾	X	N/S	1200		3,5	60	0,60	1:54
Wool/Hand wash	X	30	X	H	800		2	58	0,28	0:52
Dark wash	X	40	X	E	1200		3	40	0,53	1:15
Time program	X	30		E	1000		2	-	-	-
Auto program	X	40	X	N	1800		9	-	-	-
Quick program	X	❄	X	N	1600		9	40	0,50	0:30
Heavy	X	60	X	I	1800		9	100	2,50	2:46
Easy care	X	40	X	N/S	1200		3,5	60	0,65	1:57
Jeans	X	40	X	E	1200		3,5	50	0,60	1:18
Shirts	X	40	X	E	1200		3,5	45	0,45	1:09
Steam Refresh					-	-	1,5	-	-	0:20
Quick Pro	X	40	X	N	1200		4	40	0,50	0:59
Hygiene	X	60	X	I	1800		5	87	1,80	2:27
Sports wear	X	40	X	E	1200		3,5	43	0,40	0:55
Conditioning			X		1200		3,5	15	0,03	0:23
Stain program	X	40	X	I	1800		9	-	-	-
Bedding	X	60	X	N	1800		4	52	1,67	2:15
Allergy program cotton	X	60	X	I	1800		9	95	1,85	2:43
Allergy program synthetics	X	60	X	N/S	1200		4	70	1,10	2:32
Rinse			X	N	1800		3,5	30	0,06	0:29
Spin				-	1800		9	-	0,06	0:17
Drain				-			9	-	0,01	0:01
Drum cleaning				S				-	-	-

❄ Cold wash

**Agitation level (I = Intensive rhythm, N = Normal rhythm, E = Extra sensitive rhythm, S = Sensitive rhythm, H = Hand wash rhythm)

¹⁾ PRODUCT INFORMATION SHEET According to EU-Regulation No. 2019/2014

²⁾ 40 °C program for testing institutes. The 40 °C option has to be set.

The above table includes several examples of the use of energy, water, and time for several different program settings. Actual consumption or duration may vary depending on the water pressure, water hardness, water inlet temperature, room temperature, weight and type of load, changes in power supply, and selected options or settings. In the examples specified here, the draining is set to Normal and no additional options are selected.

Maximum or nominal load applies to laundry prepared pursuant to the IEC 60456 standard.

Adjustment of the displayed washing time

Advanced technology allows the appliance to sense the amount of laundry and add the required amount of water during the washing process. Depending on the washing load, washing time can be longer or shorter and the time displayed will be adjusted accordingly.

Moreover, displayed washing time may change due to differences in inlet water temperature. At low inlet water temperatures, washing time can be longer; at higher temperatures, it can be shorter.

Unevenly distributed laundry or lumps of laundry in the washing machine drum can cause problems such as vibration and noisy operation. The appliance can sense such lumps and will try to redistribute the laundry. Smaller loads (e.g. one towel, one sweater, one bathrobe etc.) or clothes made of materials with special geometrical properties are virtually impossible to distribute evenly across the washing machine drum (slippers, large items etc.). This results in several attempts to redistribute the laundry, which in turn leads to longer program duration.

TABLE: WASHING MODE/TEMPERATURE

Program	Washing mode					
	Normal / Off	Green	Speed	Allergy	Night	Intense
Universal wash	* - 90°C	20°C - 90°C	* - 90°C	30°C - 90°C	* - 90°C	40°C-90°C
Cotton	* - 90°C	20°C - 90°C	* - 90°C		* - 90°C	40°C-90°C
Eco 40-60						
Mix/Synthetics	* - 60°C	20°C - 60°C	* - 60°C	30°C - 60°C	* - 60°C	40°C-60°C
Wool/Hand wash	*, 30°C - 40°C		*, 30°C - 40°C			
Dark wash	*, 30°C - 40°C		*, 30°C - 40°C	30°C - 40°C	*, 30°C - 40°C	40°C
Time program	❄-60°C/ ❄-90°C					
Auto program	* - 90°C					
Quick program	*, 40°, 60°, 90°C					
Heavy	* - 90°C			30°C - 90°C	* - 90°C	
Easy care	* - 60°C	20°C - 60°C	* - 60°C	30°C-60°C	* - 60°C	40°C-60°C
Jeans	*, 30°C - 40°C		*, 30°C - 40°C	30°C-40°C	*, 30°C - 40°C	40°C
Shirts	*, 30°C - 40°C/ *, 30°C-60°C		*, 30°C - 40°C/ *, 30°C-60°C		*, 30°C - 40°C	
Steam Refresh						
Quick Pro	40°C/ 40-60°C					
Hygiene	60°C - 90°C				60°C-90°C	
Sports wear	30°C - 40°C/ *, 30°C-60°C					
Conditioning						
Stain program	30°, 40°, 60°, 90°C					
Bedding	40°C - 90°C		40°C - 90°C		40°C - 90°C	40°C - 90°C
Allergy program cotton	60°C - 90°C					
Allergy program synthetics	60°C					
Rinse						
Spin						
Drain						
Drum cleaning						

* Cold wash

TABLE OPTIONS

Program	Options					
	Spinning speed (rpm)	Super Rinse	Prewash	High water level	Anti-crease	Start delay
Universal wash	1800	✓	✓	✓	✓	✓
Cotton	1800	✓	✓	✓	✓	✓
Eco 40-60	1800					✓
Mix/Synthetics	1200	✓	✓	✓	✓	✓
Wool/Hand wash	800	✓	✓	✓	✓	✓
Dark wash	1200	✓	✓	✓	✓	✓
Time program	1000/1800				✓	
Auto program	1800	✓	✓		✓	✓
Quick program	1200/1600	✓	✓	✓	✓	✓
Heavy	1800	✓		✓	✓	✓
Easy care	1200	✓	✓	✓	✓	✓
Jeans	1200	✓	✓	✓	✓	✓
Shirts	1200	✓	✓	✓	✓	✓
Steam Refresh						✓
Quick Pro	1200/1800		✓		✓	✓
Hygiene	1800	✓	✓	✓	✓	✓
Sports wear	1200	✓	✓	✓	✓	✓
Conditioning	1200	✓		✓	✓	✓
Stain program	1800	✓			✓	✓
Bedding	1800	✓	✓	✓	✓	✓
Allergy program cotton	1800	✓	✓		✓	✓
Allergy program synthetics	1200	✓	✓		✓	✓
Rinse	1800	✓		✓	✓	✓
Spin	1800					✓
Drain	/					✓
Drum cleaning	/					✓

✓ Option (setting) available on Program

DISPOSAL

Disposal / recycling of packaging



Our product packaging is made of environmentally friendly materials that can be recycled, disposed of, or destroyed without any hazard to the environment. To this end, packaging materials are labelled appropriately.

The symbol on the product or its packaging indicates that the product should not be treated as normal household waste. The product should be taken to an authorized collection centre for waste electric and electronic equipment processing.

When disposing of an appliance at the end of its useful life, remove all power cords and destroy the door latch and switch to prevent the door from locking or latching (child safety).

Correct disposal of the product will help prevent any negative effects on the environment and health of people which could occur in case of incorrect product removal. For detailed information on removal and processing of the product, please contact the relevant authority in charge of waste management, your waste disposal service, or the store where you bought the product.

NOTES

A large area for taking notes, consisting of two columns of horizontal dotted lines.

NOTES

A large area for writing notes, consisting of two columns of horizontal dotted lines.



QUICK GUIDE

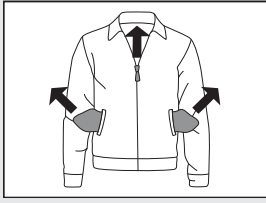

1.

SORT THE LAUNDRY.

Close the zippers.
Empty the pockets and turn them inside out.
Check the laundry care symbols.
Sort the laundry based on how heavily soiled it is, by colour, and by material.

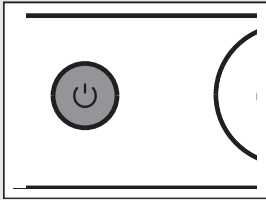

2.

SWITCH ON THE MAIN ON/OFF SWITCH (ON/OFF)

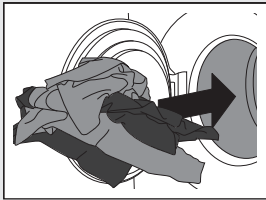

3.

OPEN THE WASHING MACHINE DOOR AND INSERT THE LAUNDRY.

Before doing so, make sure the drum is empty.

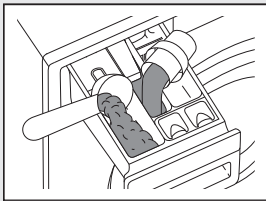

4.

ADD THE DETERGENT AND THE CONDITIONER.

Recommended detergent amount is usually indicated on the packaging.
For smaller wash loads, use a smaller amount of detergent.
See chapter "SPECIAL FEATURES" for ADS settings.

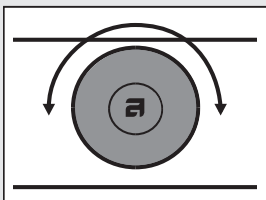

5.

CHOOSE THE WASHING PROGRAM.

Turn the program selector knob to the desired washing program.
Selected program will be indicated on the display unit.

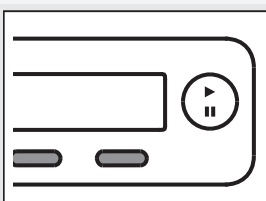

6.

CHOOSE THE PROGRAM SETTING.

Choose the settings by pressing the relevant buttons.

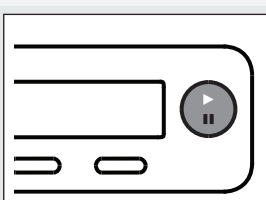

7.

CLOSE THE WASHING MACHINE DOOR AND PRESS THE "START" BUTTON.

Anticipated washing time, in hours and minutes, will be indicated on the display.

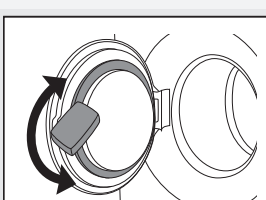

8.

END OF PROGRAM

Open the door and remove the laundry from the washing machine.
See chapter "CLEANING AND MAINTENANCE".
Close the door.
Switch off the main on/off switch.
Close the water tap and remove the power plug from the power socket.

We reserve the right to modifications.



Gorenje, Partizanska 12, 3320 Velenje, Slovenija
www.asko.com

WM75.2



CE
en (05-22)